



400 Series

User manual



Table of contents:

1. SAFETY PRECAUTIONS AND PROCEDURES	4
1.1. Preliminary instructions	4
1.2. During use	4
1.3. After use	5
1.4. Overvoltage categories - definitions	5
2. GENERAL DESCRIPTION	6
2.1. Introduction	6
2.2. Instrument operation	6
3. PREPARATION FOR USE	7
3.1. Initial checks	7
3.2. Instrument power supply	7
3.3. Calibration	7
3.4. Storage	7
4. NOMENCLATURE	8
4.1. Instrument description	8
4.2. Backlighting	8
4.3. Keyboard description	9
4.4. Display description	9
4.5. Initial screen	9
5. MAIN MENU	10
5.1. AUTO ÷ PWR	10
5.2. SET – Instrument settings	10
5.2.1. Language	10
5.2.2. Auto Power OFF	11
5.2.3. Nominal voltage	11
5.2.4. Frequency	11
5.2.5. System	11
5.3. MEM	11
5.4. RS232	11
6. OPERATING INSTRUCTIONS	12
6.1. AUTO	12
6.1.1. Description of anomalous results	14
6.2. LOWOHM: Continuity test of earth leads with 200mA	17
6.2.1. CAL mode	19
6.2.2. Description of anomalous results	20
6.3. MΩ: Measurement of the insulation resistance	22
6.3.1. Description of anomalous results	24
6.4. RCD: Test on A-type and AC-type RCDs	26
6.4.1. AUTO mode	28
6.4.2. x½ mode	29
6.4.3. x1, x2, x5 mode	30
6.4.4.  mode	31
6.4.5. RA mode	32
6.4.6. Description of anomalous results	32
6.5. LOOP: Measurement of Line/Loop impedance	36
6.5.1. P-N mode	38
6.5.2. P-P mode	39
6.5.3. P-PE mode in TT or TN systems	40
6.5.4. P-PE mode in IT systems	41
6.5.5. Description of anomalous results	41
6.6. R _A : measurement of the total earth resistance through the socket-outlet	44
6.6.1. Description of anomalous results	46
6.7. 123: Phase sequence test	49
6.7.1. Description of anomalous results	52
6.8. AUX: real time measurement of the environmental parameters	52
6.8.1. AIR, RH, TMP °F, TMP °C, Lux mode	54

6.8.2.	Description of anomalous results.....	54
6.9.	LEAK: real time measurement of the leakage current through an external clamp	55
6.9.1.	Description of anomalous results.....	56
7.	MAINS ANALYSIS.....	57
7.1.	PWR: real time measurement of the mains parameters	57
7.1.1.	PAR mode.....	58
7.1.2.	HRM V and HRM I mode	58
8.	MEMORY	59
8.1.	How to save a measure.....	59
8.1.1.	Description of anomalous results.....	59
8.2.	Saved data management	60
8.2.1.	How to recall a measure	60
8.2.2.	How to delete the last measure or all of them	61
8.2.3.	Description of anomalous results.....	61
9.	CONNECTING THE INSTRUMENT TO THE PC.....	62
10.	MAINTENANCE.....	63
10.1.	General.....	63
10.2.	Battery replacement	63
10.3.	Instrument cleaning.....	63
10.4.	End of life	63
11.	SPECIFICATIONS.....	64
11.1.	Technical features.....	64
11.2.	Reference guidelines.....	68
11.2.1.	General	68
11.2.2.	Reference standards for verification measurements	68
11.3.	General characteristics.....	68
11.4.	ENVIRONMENT.....	68
11.4.1.	Environmental working conditions	68
11.5.	Accessories	68
12.	SERVICE.....	69
12.1.	Warranty conditions.....	69
12.2.	Service	69
13.	PRACTICAL REPORTS FOR ELECTRICAL TESTS	70
13.1.	Continuity measurement on protective conductors	70
13.1.1.	Purpose of the test.....	70
13.1.2.	Installation parts to be checked	70
13.1.3.	Allowable values	70
13.2.	Insulation resistance measurement.....	71
13.2.1.	Purpose of the test.....	71
13.3.	Check of the circuit separation	74
13.3.1.	Definitions	74
13.3.2.	Purpose of the test.....	74
13.3.3.	Installation parts to be checked	74
13.3.4.	Allowable values	74
13.4.	Working test of RCDS	76
13.4.1.	Purpose of the test.....	76
13.4.2.	Installation parts to be checked	76
13.4.3.	Allowable values	76
13.4.4.	Note.....	76
13.5.	Test of RCD tripping current.....	77
13.5.1.	Purpose of the test.....	77
13.5.2.	Installation parts to be checked	77
13.5.3.	Allowable values	77
13.5.4.	Note.....	77
13.6.	Measurement of short-circuit impedance	78
13.6.1.	Purpose of the test.....	78
13.6.2.	Installation parts to be checked	78
13.6.3.	Allowable values	78

13.7. Fault loop impedance measurement	78
13.7.1. Purpose of the test.....	78
13.7.2. Installation parts to be checked	78
13.7.3. Allowable values	78
13.8. Earth resistance measurement in TT systems	79
13.8.1. Purpose of the test.....	79
13.8.2. Installation parts to be checked	79
13.8.3. Allowable values	79
13.9. Voltage and current Harmonics	80
13.9.1. Theory	80
13.9.2. Limit values for harmonics	80
13.9.3. Presence of harmonics: causes.....	81
13.9.4. Presence of harmonics: consequences.....	82
13.10. Power and Power Factor definition	82
13.10.1. Note.....	83
13.10.2. Conventions on powers and power factors	83

1. SAFETY PRECAUTIONS AND PROCEDURES

The models of 400 Series (ISO410, SPEED418S, COMBI419S, COMBI420S and COMBI421) were designed in compliance with the following Directives IEC/EN61557 and IEC/EN61010, relative to electronic. Before and while measuring, carefully follow the instructions below:

- Do not perform voltage or current measurements in humid environments.
- Do not perform measurements near explosive gas or material and fuels or in dusty environments.
- Avoid contact with the circuit tested if no measurement is being performed.
- Avoid contact with exposed metal parts, test terminals not in use, circuits, etc.
- Do not perform any measurement if instrument anomalies are detected, such as deformations, breaks, leakage of substances, no display reading, etc.
- Pay special attention when measuring voltages above 25V in special environments (building yards, swimming pools...) and above 50V in ordinary environments, as there is a risk of electric shock.
- Only use original HT accessories.

In this manual, following symbols are used:



CAUTION: Follow the instructions given in this manual; improper use may damage the instrument, its components or create dangerous situations for the operator.



DC or AC voltage or current.



Unidirectional pulsating voltage or current.

1.1. PRELIMINARY INSTRUCTIONS

- This instrument has been designed for use in the environmental conditions specified in § 11.2.1 and § 11.4.1. Do not use in different environmental conditions.
- The instrument may be used for measuring and verifying the safety of electrical systems. Do not use on systems exceeding the limit values specified in § 11.2.1.
- We recommend following the ordinary safety rules aimed at: your protection against dangerous currents, the instrument's protection against improper use.
- Only the accessories provided with the instrument guarantee compliance with safety standards. They must be in good conditions and must be replaced, if necessary, with identical models.
- Check that batteries are correctly inserted.
- Before connecting the test leads to the circuit being tested, check that the desired function has been selected.

1.2. DURING USE

We recommend carefully reading the following recommendations and instructions:

CAUTION





Failure to comply with the CAUTIONs and/or instructions may damage the instrument and/or its components or cause dangers for the operator.

- Before changing function, disconnect the test leads from the circuit tested.
- When the instrument is connected to the circuit tested, never touch any lead, even if not in use

- Avoid measuring resistance with external voltages; although the instrument is protected, an excessive voltage may cause damage.
- While measuring current, place the clamp toroid as far as possible from the conductors not involved in measurement, as the magnetic field they produce could interfere with the measuring operations.
- During current measurement, place the conductor as much as possible in the middle of the toroid so as to optimize precision.
- While measuring voltage, current, etc., if the value of the quantity being tested remains unchanged, check and, if necessary, disable the STOP function.

CAUTION



The symbol  indicates the charge level. When there are five bars next to the battery symbol, it means that batteries are fully charged; a decrease in the number of bars to "" indicates that the batteries are almost low. In this case, interrupt tests and replace the batteries according to the indications given in § 10.2. **The instrument is able to keep data stored also with no batteries.**

1.3. AFTER USE

When measuring operations are completed, turn off the instrument by pressing and holding the ON/OFF key for a few seconds. Should the instrument remain unused for a long time, remove batteries and follow the indications given in § 3.4.

1.4. OVERVOLTAGE CATEGORIES - DEFINITIONS

Standard IEC/EN61010-1 (Safety requirements for electrical equipment for measurement, control and laboratory use, Part 1: General requirements) defines what a measurement category (usually called "overvoltage category") is. At § 6.7.4: Measuring circuits it says:

Circuits are divided into the following measurement categories:

- **Measurement category IV** is for measurements performed at the source of the low-voltage installation.
Examples are electricity meters and measurements on primary overcurrent protection devices and ripple control units.
- **Measurement category III** is for measurements performed in the building installation.
Examples are measurements on distribution boards, circuit breakers, wiring, including cables, bus-bars, junction boxes, switches, socket-outlets in the fixed installation, and equipment for industrial use and some other equipment, for example, stationary motors with permanent connection to fixed installation.
- **Measurement category II** is for measurements performed on circuits directly connected to the low voltage installation.
Examples are measurements on household appliances, portable tools and similar equipment.
- **Measurement category I** is for measurements performed on circuits not directly connected to MAINS.
Examples are measurements on circuits not derived from MAINS, and specially protected (internal) MAINS-derived circuits. In the latter case, transient stresses are variable; for that reason, the norm requires that the transient withstand capability of the equipment is made known to the user.

2. GENERAL DESCRIPTION

2.1. INTRODUCTION

This user manual is referred to the following models **ISO410**, **SPEED418S**, **COMBI419S**, **COMBI420S** and **COMBI421**. Unless otherwise specified, the “instrument” is referred to COMBI421 model. The following Table 1 shows the possible measuring functions:

Funzione	ISO410	SPEED418S	COMBI419S	COMBI420S	COMBI421
AUTO (Ra + RCD + MΩ)			✓	✓	✓
LOWΩ	✓		✓	✓	✓
MΩ	✓		✓	✓	✓
RCD \sim e \sim		✓	✓	✓	✓
Ra		✓	✓	✓	✓
LOOP		✓	✓	✓	✓
123		✓	✓	✓	✓
AUX				✓	✓
LEAKAGE			✓	✓	✓
POWER				✓	✓

Table 1: Characteristics of models

2.2. INSTRUMENT OPERATION

The instrument can perform following tests (compatibly with the characteristics described in the table above):

- **AUTO** Test which automatically performs the following test sequence: total earth resistance through socket, tripping time of the differential switch, insulation resistance between phase and earth.
- **LOWΩ** Continuity test of earth conductors, protective conductors and equipotential conductors with test current higher than 200mA and open circuit voltage between 4V and 24V.
- **MΩ** Insulation resistance measurement with a direct test voltage of 50V, 100V, 250V, 500V or 1000V.
- **RCD** Measurement of following parameters on A-type (\sim) and AC-type (\sim) general and/or selective differential switches with nominal current up to 1A: tripping time, tripping current, contact voltage (U_t), total earth resistance (RA).
- **LOOP** Measurement of line impedance and fault loop impedance with calculation of the assumed fault current.
- **Ra** Measurement of total earth resistance with 15mA without causing the differential protections' tripping.
- **123** Indication of the phase sequence.
- **AUX** Measurement of the environmental parameters (temperature, humidity, air speed and lighting) by means of optional probes.
- **LEAKAGE** Function for measuring leakage current in real time by means of an (optional) HT96U clamp.
- **POWER** Real-time displaying the values of the electrical quantities in a single-phase system and the harmonic analysis of voltage and current up to the 49th harmonic with THD% calculation.

3. PREPARATION FOR USE

3.1. INITIAL CHECKS

Before shipment, the instrument's electronics and mechanics have been carefully checked. All possible precautions have been taken in order for the instrument to be delivered in optimum conditions. However, we recommend rapidly checking the instrument in order to detect possible damage occurred during transport. Should you detect anomalies, please immediately contact the dealer.

It is also recommended to check that the package contains all parts indicated in § 11.5. In case of discrepancies, please contact the dealer. Should it be necessary to return the instrument, please follow the instructions given in § 12.

3.2. INSTRUMENT POWER SUPPLY

The instrument is battery supplied. For battery type and life, see § 11.3.

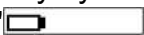
The symbol "" indicates the charge level. When there are five bars next to the battery symbol, it means that batteries are fully charged; a decrease in the number of bars to "" indicates that the batteries are almost low. In this case, interrupt tests and replace the batteries according to the indications given in § 10.2.

The instrument is able to keep data stored also with no batteries.

For the insertion of batteries, follow the indications given in § 10.2.

The instrument is provided with advanced algorithms to maximize the batteries' life. In particular:

- The instrument automatically turns off the display's back lighting after ca. 5 seconds.
- In order to increase battery autonomy, should the voltage supplied by batteries be too low, the instrument disables the display's back-lighting function.

3.3. CALIBRATION

The instrument's technical specifications are those described in this manual. Its performance is warranted for one year from the date of purchase.

3.4. STORAGE

In order to guarantee precise measures, after the instrument has remained stored for a long time under extreme environmental conditions, wait for the instrument to return to normal conditions (see the environmental specifications listed in § 11.4.1).

4. NOMENCLATURE

4.1. INSTRUMENT DESCRIPTION

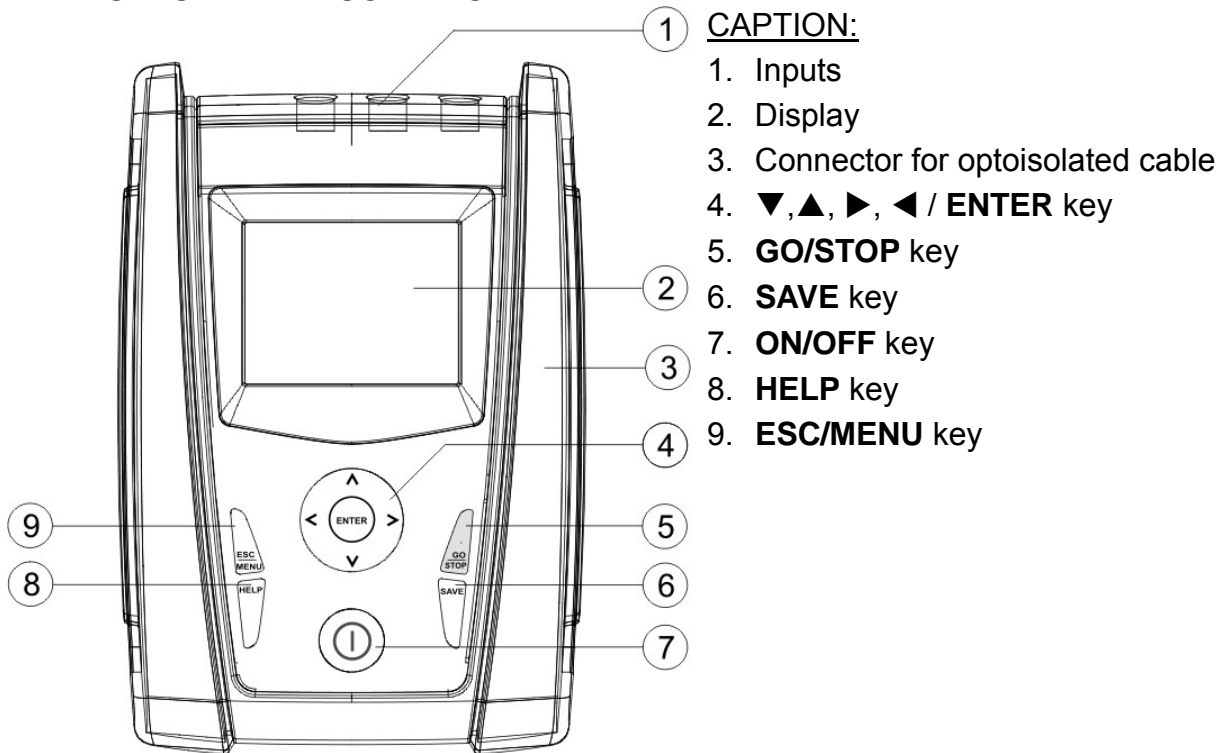
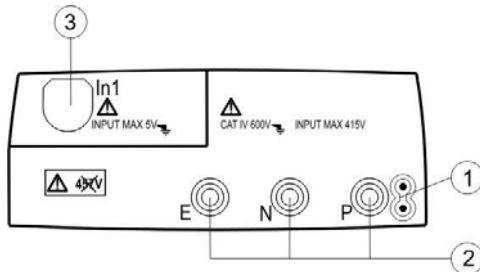

Fig. 1: Description of the front part of the instrument



CAPTION:

1. Connector for remote probe
2. E, N, P inputs
3. In1 input

Fig. 2: Description of the upper part of the instrument

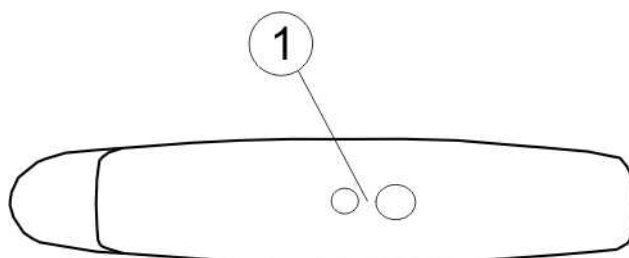

CAPTION:

1. Connector for optoisolated cable

Fig. 3: Description of the instrument's side

4.2. BACKLIGHTING

During instrument operation, a further short pressing of the key turns on the display's backlighting (if battery voltage level is sufficiently high). In order to preserve battery efficiency, backlighting automatically turns off after ca. 20 seconds.

A frequent use of back lighting reduces the batteries' life.

4.3. KEYBOARD DESCRIPTION

The keyboard includes following keys:



ON/OFF key to switch on/off the instrument



ESC key to exit the selected menu without confirming
MENU key to activate menu management



◀ ▶ ▲ ▼ keys to move the cursor through the different screens in order to select the desired programming parameters
ENTER key to confirm the modifications and the selected programming parameters and to select the function from the menu



GO key to start measurements
STOP key to stop measurements



SAVE key to save the measured values



HELP key (long pressure) to display an indicative scheme of the connections between the instrument and the system being tested in the function set
☀ key (short pressure) to turn on the display's backlighting

4.4. DISPLAY DESCRIPTION

The display is a graphic module with a resolution of 128 x 128 dots. The display's first line indicates the type of active measurement and the battery charge indicator

LOW Ω			
-.-.- Ω			
R+		R-	
-.-.- Ω		-.-.- Ω	
-.-. mA		-.-. mA	
Measuring...			
AUTO	1.00 Ω		0.12 Ω
Func	Lim		CAL

4.5. INITIAL SCREEN

When turning on the instrument the instrument displays an initial screen for a few seconds. It displays the following:

- the instrument's model
- the manufacturer's name
- the serial number (SN:) of the instrument
- the firmware version (FW:) in the instrument's memory
- the date of calibration (Calibration:).

COMBI 421			
HT ITALIA			
SN: 14020100			
FW: 1.22			
Calibration:			
22/05/2014			

Then, the instrument switches to the last function selected.

5. MAIN MENU

Pressing the **MENU/ESC** key in any allowable condition of the instrument displays the following screen, in which the instrument may be set, the saved measures can be displayed and the desired measuring function may be set.

MENU	
AUTO	: Ra, RCD, MΩ
LOWΩ	: continuity
MΩ	: insulation
RCD	: RCD tripping
LOOP	: impedance
Ra	: earth res.
123	: phase sequen.
AUX	: environment
LEAK	: leakage curr.
PWR	: analyzer
▶ SET	: settings
MEM	: memory
RS232	: data transfer

5.1. AUTO ÷ PWR

By selecting one of the measurements listed between AUTO and PWR with the cursor, compatibly with the characteristics reported in Table 1 and confirming selection with **ENTER**, the desired measurement is accessed.

5.2. SET – INSTRUMENT SETTINGS

Move the cursor to **SET** by means of the arrow keys (**▲**, **▼**) and confirm with **ENTER**. Subsequently, the displays shows the screen which allows accessing the various instrument settings.

The settings will remain valid also after switching off the instrument.

SET	
Language	
Auto power off	
Nominal V	
Frequency System	
↑↓	
VAL	

5.2.1. Language

Move the cursor to **Language** by means of the arrow keys (**▲**, **▼**) and confirm with **ENTER**. Subsequently, the displays shows the screen which allows setting the instrument language.

Select the desired option by means of the arrow keys (**▲**, **▼**). To store settings, press the **ENTER** key, to exit the changes made, press the **ESC** key.

LNG	
Italiano	
English	
Español	
Deutsch	
Français	
Svenska	
Norsk	
Dansk	
↑↓	
VAL	

5.2.2. Auto Power OFF

Move the cursor to **Auto power off** by means of the arrow keys (**▲**,**▼**) and confirm with **ENTER**. Subsequently, the displays shows the setting screen which allows enabling/disabling the auto power off of the instrument after a period of 5 minutes inactivity.

Select the desired option by means of the arrow keys (**▲**,**▼**). To store settings, press the **ENTER** key, to exit the changes made, press the **ESC** key.

OFF		[Battery Icon] [Signal Icon]	
ON 5 min			
OFF			
↑↓			
VAL			

5.2.3. Nominal voltage

Move the cursor to **Nominal V** by means of the arrow keys (**▲**,**▼**) and confirm with **ENTER**. Subsequently, the displays shows the screen which allows setting the value of the voltage to be used for calculating the prospective short-circuit current.

Select the desired option by means of the arrow keys (**▲**,**▼**). To store settings, press the **ENTER** key, to exit the changes made, press the **ESC** key.

VNOM		[Battery Icon] [Signal Icon]	
Vp-n=230V Vp-p=400V			
Vp-n=240V Vp-p=415V			
↑↓			
VAL			

5.2.4. Frequency

Move the cursor to **Frequency** by means of the arrow keys (**▲**,**▼**) and confirm with **ENTER**. Subsequently, the displays shows the screen which allows setting the value of the mains frequency.

Select the desired option by means of the arrow keys (**▲**,**▼**). To store settings, press the **ENTER** key, to exit the changes made, press the **ESC** key.

FREQ		[Battery Icon] [Signal Icon]	
50 Hz			
60 Hz			
↑↓			
VAL			

5.2.5. System

Move the cursor to **System** by means of the arrow keys (**▲**,**▼**) and confirm with **ENTER**. Subsequently, the display shows the screen which allows selecting the type of electric power supply system. The “**GO STOP**” item allows to eventually disable the check of voltage on PE conductor by pressing the **GO/STOP** key

Select the desired option by means of the arrow keys (**▲**,**▼**). To store settings, press the **ENTER** key, to exit the changes made, press the **ESC** key.

SYS		[Battery Icon] [Signal Icon]	
TT/TN system			
IT system			
GO STOP			
↑↓			
VAL			

5.3. MEM

By selecting **MEM** with the cursor and confirming selection with **ENTER**, the memory management is accessed (§ 8)

5.4. RS232

Select the item **RS232** to enable the management of data transfer to PC (see § 9)

6. OPERATING INSTRUCTIONS



Press (short pressure) the key to activate the display's backlighting should it be difficult to read the display.



Press (long pressure) the **HELP** key to display an indicative scheme of the connections between the instrument and the system being tested in the function set



Should more help screens be available for the same function, use the **▲** and **▼** keys to scroll them.



Press the **ESC** key to exit the on-line help and go back to the selected measurement.

6.1. AUTO

This function enables performing an automatic sequence of tests, including the main tests regarding the electric safety of a system, i.e.:

- Measurement of earth resistance through socket-outlet
- Measurement of RCD tripping time
- Measurement of insulation resistance between phase and earth

CAUTION



Testing the RCD's tripping time causes the RCD's tripping. **Therefore, check that there are NO users or loads connected downstream of the RCD being tested which could be damaged by a system downtime.**

Disconnect all loads connected downstream of the RCD as they could produce leakage currents further to those produced by the instrument, thus invalidating the results of the test

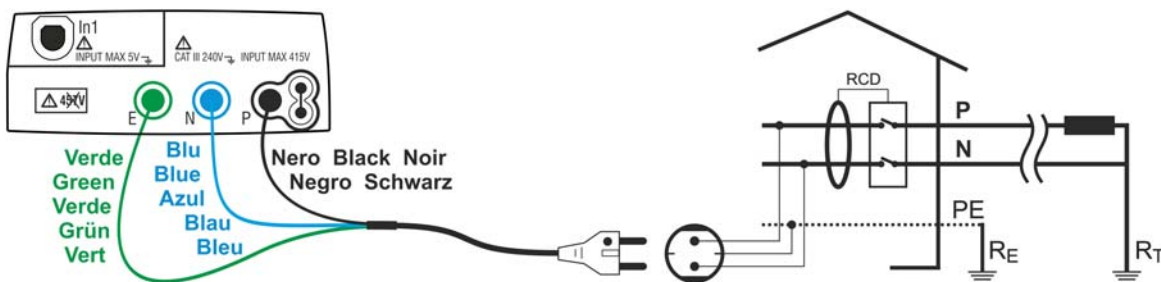

Fig. 4: Instrument connection through shuko cable

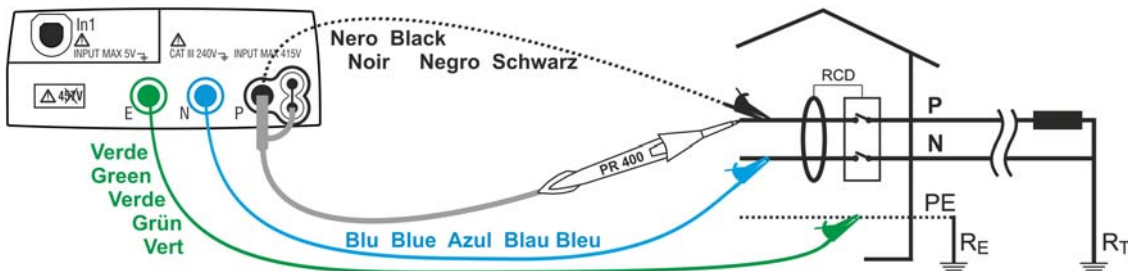

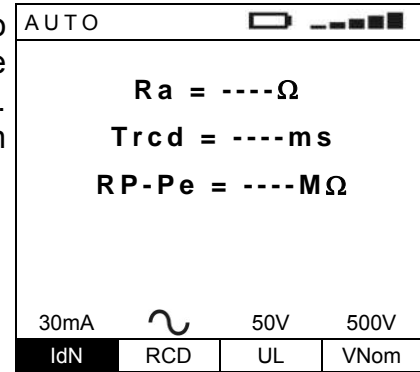



Fig. 5: Instrument connection by means of single cables and remote probe

1.  Press the **MENU** key, move the cursor to **AUTO** in the main menu by means of the arrow keys (**▲**, **▼**) and confirm with **ENTER**. Subsequently the instrument displays a screen similar to the one reported here to the side.



2.  Use the **◀**, **▶** keys to select the parameter to be modified, and the **▲**, **▼** keys to modify the parameter value. **It is not necessary to confirm the selection with ENTER.**

IdN The virtual IdN key allows setting the nominal value of the RCD's tripping current, which may be: **10mA, 30mA, 100mA, 300mA, 500mA, 650mA, 1A**

CAUTION



Make sure to select the correct value when setting the RCD's test current. If setting a current higher than the nominal current of the device being tested, the RCD would be tested at a current higher than the correct one, thus facilitating a faster tripping of the switch

RCD The virtual RCD key enables the selection of the RCD type, which may be: **AC, AC S, A, A S** (the options A, A S are not available if the electrical system set is IT)

CAUTION



When activating the test option for selective RCDs (symbol **S**), the time interval between the tests is 60 seconds (30 seconds for tests with $\frac{1}{2}IdN$). The instrument display shows a timer indicating the time remaining before the instrument can automatically perform the test.

UL The virtual UL key allows setting the limit value of contact voltage for the system being tested, which may be: **25V, 50V**

VNom The virtual VNom allows setting the value of test voltage for insulation measurement, which may be: **50V, 100V, 250V, 500V, 1000V**

3. Insert the green, blue and black connectors of the three-pin shuko cable into the corresponding input leads E, N and P of the instrument. As an alternative, use the single cables and apply the relevant alligator clips to the free ends of the cables. It is also possible to use the remote probe by inserting its multipolar connector into the input lead P. Connect the shuko plug, the alligator clips or the remote probe to the electrical mains according to Fig. 4 and Fig. 5

4.  Press the **GO/STOP** key on the instrument or the **START** key on remote probe. The instrument will start the automatic test sequence.

CAUTION



If message "**Measuring...**" appears on the display, the instrument is performing measurement. During this whole stage, do not disconnect the test leads of the instrument from the mains.

5. Once the test is completed, if all measured values are correct, the instrument gives a double acoustic signal and displays the message "OK", which signals that the test has been completed successfully, and a screen similar to the one reported here to the side

AUTO			
Ra = 49.1Ω			
Trcd = 24ms			
RP-Pe > 999MΩ			
OK			
30mA	~	50V	500V
IdN	RCD	UL	VNom

Value of earth resistance

Value of the RCD's tripping time

Value of the phase-to-earth insulation resistance

6. The results displayed can be saved by pressing the **SAVE** key twice or the **SAVE** key and, subsequently, the **ENTER** key (§ 8.1)

6.1.1. Description of anomalous results

1. The instrument detects a resistance higher than the calculated limit value UL/IdN (1666Ω @ UL=50V and IdN=30mA) or higher than the full scale value. A screen similar to the one reported here to the side is displayed, a long acoustic signal is given and the automatic test is interrupted

AUTO			
Ra = 1789Ω			
Trcd = ----ms			
RP-Pe = ----MΩ			
NOT OK			
30mA	~	50V	500V
IdN	RCD	UL	VNom

Value of earth resistance

2. The instrument detects that the RCD trips out of its limit time, or does not trip at all. A screen similar to the one reported here to the side is displayed, a long acoustic signal is given and the automatic test is interrupted

AUTO			
Ra = 1789Ω			
Trcd > 999ms			
RP-Pe = ----MΩ			
NOT OK			
30mA	~	50V	500V
IdN	RCD	UL	VNom

Value of earth resistance

Value of the RCD's tripping time

3. If the measured phase-to-earth insulation value is lower than the set limit, the instrument displays a screen similar to the one reported here to the side and gives a long acoustic signal

AUTO			
$R_a = 1789\Omega$ $Trcd > 999ms$ $RP-Pe = 0.01M\Omega$			
NOT OK			
30mA		50V	500V
IdN	RCD	UL	VNom

Value of earth resistance

Value of the RCD's tripping time

Value of the phase-to-earth insulation resistance

- 4.



The results displayed can be saved by pressing the **SAVE** key twice or the **SAVE** key and, subsequently, the **ENTER** key (§ 8.1)

5. If the instrument detects that the phase and neutral leads are inverted, the message reported here to the side is displayed. Rotate the shuko plug or check the connection of the single cables

AUTO			
$R_a = ----\Omega$ $Trcd = ----ms$ $RP-Pe = ----M\Omega$			
REVERSE P-N			
30mA		50V	500V
IdN	RCD	UL	VNom

The phase and neutral conductors are inverted

6. If the instrument detects that the phase and earth leads are inverted, the message reported here to the side is displayed. check the connection of the cables

AUTO			
$R_a = ----\Omega$ $Trcd = ----ms$ $RP-Pe = ----M\Omega$			
REVERSE P-PE			
30mA		50V	500V
IdN	RCD	UL	VNom

The phase and earth conductors are inverted

7. If the instrument detects a phase-to-neutral voltage and a phase-to-earth voltage lower than the limit, the message reported here to the side is displayed. Check that the system being tested is energized

AUTO			
$R_a = ----\Omega$ $Trcd = ----ms$ $RP-Pe = ----M\Omega$			
Low voltage			
30mA		50V	500V
IdN	RCD	UL	VNom

Insufficient voltage

8. If the instrument detects a phase-to-neutral voltage or a phase-to-earth voltage higher than the limit, the message reported here to the side is displayed. Check that the instrument is not phase-to-phase connected

AUTO							
Ra = ----Ω Trcd = ----ms RP-Pe = ----MΩ							
High voltage							
30mA				50V		500V	
IdN		RCD		UL		VNom	

High voltage detected

9.  The previous anomalous results cannot be saved

6.2. LOWOHM: CONTINUITY TEST OF EARTH LEADS WITH 200mA

This function is performed in compliance with standard IEC/EN61557-4 and allows measuring the resistance of protective and equipotential conductors. The following operating modes are available:

- **CAL** compensation of the resistance of the cables used for measurement. The instrument automatically subtracts the value of cable resistance from the measured resistance value. It is therefore necessary that this value is measured (by means of the **CAL** function) each time the test cables are changed or extended
- **AUTO** the instrument performs two measurements with inverted polarity and displays the average value of the two measures. Recommended mode for continuity test
- **R+** measurement with positive polarity and with the possibility of setting a test duration time. In this case, the operator may set a measuring time long enough to be able to move the protective conductors while the instrument is performing the test, in order to detect a possible bad connection
- **R-** measurement with negative polarity and with the possibility of setting a test duration time. In this case, the operator may set a measuring time long enough to be able to move the protective conductors while the instrument is performing the test, in order to detect a possible bad connection.

CAUTION



The continuity test is performed by supplying a current higher than 200mA in case the resistance is not higher than ca. 10Ω (including resistance of the test cables saved in the instrument as offset after performing the calibration procedure). For higher resistance values, the instrument performs the test with a current lower than 200mA.

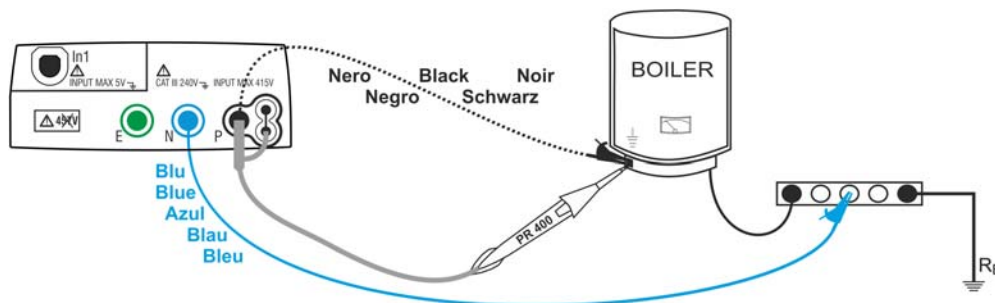



Fig. 6: Instrument connection by means of single cables and remote probe

1.



Press the **MENU** key, move the cursor to **LOWΩ** in the main menu by means of the arrow keys (**▲**, **▼**) and confirm with **ENTER**. Subsequently the instrument displays a screen similar to the one reported here to the side.

LOWΩ		■■■■■	
-----Ω			
R+		R-	
-----Ω		-----Ω	
---mA		---mA	
CAL	4.00Ω		---
Func	Lim		CAL

2.  Use the ◀, ▶ keys to select the parameter to be modified, and the ▲, ▼ keys to modify the parameter value.
It is not necessary to confirm the selection with ENTER.

Func The virtual Func key allows setting the measuring mode of the instrument, which may be: **CAL, AUTO, R+, R-**

Lim The virtual Lim key allows setting the maximum continuity limit, which may have the following values: **1.00Ω, 2.00Ω, 3.00Ω, 4.00Ω, 5.00Ω**

3. Insert the blue and black connectors of the single cables into the corresponding input leads N and P of the instrument. Apply the relevant alligator clips to the free ends of the cables. It is also possible to use the remote probe by inserting its multipolar connector into the input lead P.
4. Should the length of the cables provided be insufficient for the measurement to be performed, extend the blue cable.
5. Select the **CAL** mode to compensate the resistance of the cables used for measuring according to the instructions given in § 6.2.1.

6.  Use the arrow keys ◀, ▶ to select the virtual Func key and set the desired test mode by means of the arrow keys ▲, ▼.
It is not necessary to confirm the selection with ENTER.

CAUTION



Before connecting the test leads, make sure that there is no voltage at the ends of the conductor to be tested.

7. Connect the test leads to the ends of the conductor to be tested as in Fig. 6.

CAUTION



Always make sure, before any test, that the compensation resistance value of the cables is referred to the cables currently used. In case of doubt, repeat the cable calibration procedure as in 6.2.1.

8.  Press the **GO/STOP** key on the instrument or the **START** key on remote probe. The instrument will start the measurement.

CAUTION



If message “**Measuring...**” appears on the display, the instrument is performing measurement. During this whole stage, do not disconnect the test leads of the instrument from the conductor under test.

9.  In case the **R+** or **R-** mode has been selected, pressing the **GO/STOP** key on the instrument or the **START** key on remote probe stops the test before the set time has elapsed.

10. By using the AUTO mode, once test is completed, in case the average value between R+ and R- is lower than the set limit, the instrument gives a double acoustic signal which signals the positive result of the test and displays a screen similar to the one reported here to the side

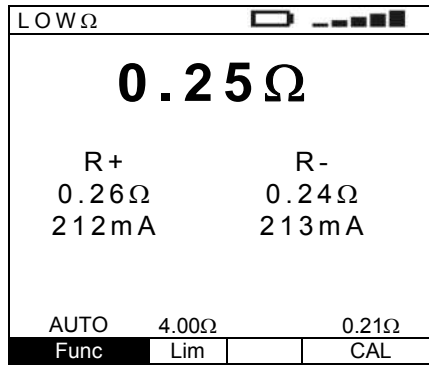

Average value between R+ and R-

Values of the test currents for R+ and R-

Values of R+ and R-, respectively

11. By using the R+ or R- mode, once test is completed, in case the detected value is lower than the set limit, the instrument gives a double acoustic signal which signals the positive result of the test and displays a screen similar to the one reported here to the side

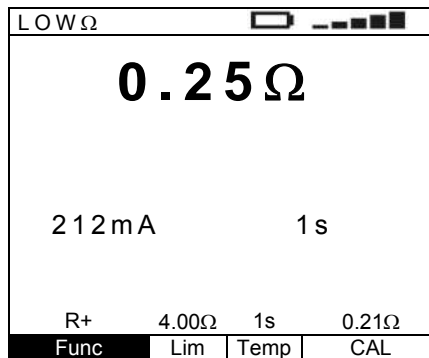

Value of resistance R+ (or R-)

Values of test current and test time

12.  The results displayed can be saved by pressing the **SAVE** key twice or the **SAVE** key and, subsequently, the **ENTER** key (§ 8.1)

6.2.1. CAL mode

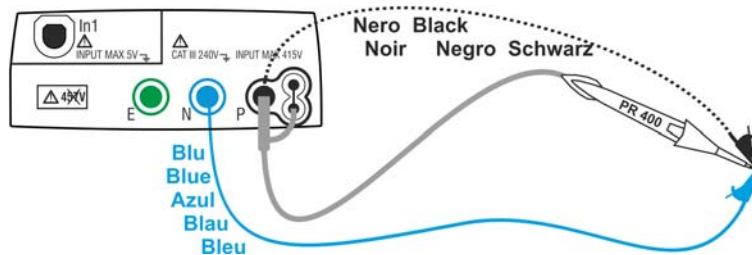



Fig. 7: Calibration of single cables and remote probe

-  Use the arrow keys ◀, ▶ to select the virtual Func key and set the CAL test mode by means of the arrow keys ▲, ▼.
It is not necessary to confirm the selection with ENTER.
- Short the leads of the measurement cables as in Fig. 7 making sure that the conductive parts of alligator clips are well in contact.
-  Press the **GO/STOP** key on the instrument or the **START** key on remote probe. The instrument starts the calibration procedure of the cables immediately followed by the verification of the compensated value.

CAUTION



If message "**Measuring...**" appears on the display, the instrument is performing measurement. If message "**Waiting verify**" appears on the display, the instrument is verifying the calibrated value. During this whole stage, do not unshort the test leads of the instrument.

4. Once calibration is completed, in case the detected value is lower than 5Ω , the instrument gives a double acoustic signal which signals the positive result of the test and displays a screen similar to the one reported here to the side

LOW Ω			
----- Ω			
R+		R-	
----- Ω		----- Ω	
---mA		---mA	
CAL	4.00 Ω		0.21 Ω
Func	Lim		CAL

Value of the calibrated resistance

5. In order to delete the compensation resistance value of the cables, it is necessary to perform a cable calibration procedure with a resistance higher than 5Ω at test leads (e.g. with open test leads).

6.2.2. Description of anomalous results

1. By using the AUTO, R+ or R- mode, in case the detected value is higher than the set limit, the instrument gives a long acoustic signal and displays a screen similar to the one reported here to the side

LOW Ω			
5.92 Ω			
R+		R-	
5.92 Ω		5.91 Ω	
210 mA		210 mA	
R > LIM			
AUTO	4.00 Ω		0.21 Ω
Func	Lim		CAL

2. By using the AUTO, R+ or R- mode, in case the detected value is higher than the full scale, the instrument gives a long acoustic signal and displays a screen similar to the one reported here to the side

LOW Ω			
>99.9 Ω			
R+		R-	
>99.9 Ω		>99.9 Ω	
---mA		---mA	
I < 200mA			
AUTO	4.00 Ω		0.21 Ω
Func	Lim		CAL

3. By using the AUTO, R+ or R- mode, if the instrument detects a resistance which prevents a current of 200mA to circulate, it gives a long acoustic signal and displays a screen similar to the one reported here to the side

LOW Ω			
20.0 Ω			
R+		R-	
20.0 Ω		20.0 Ω	
157 mA		157 mA	
I < 200mA			
AUTO	4.00 Ω		0.21 Ω
Func	Lim		CAL

4.  The results displayed can be saved by pressing the **SAVE** key twice or the **SAVE** key and, subsequently, the **ENTER** key (§ 8.1)

5. If the instrument detects a voltage value higher than 10V at the input leads, the screen reported here to the side is displayed

LOW Ω			
----- Ω			
R+		R-	
----- Ω		----- Ω	
--- mA		--- mA	
Vin > Vlim			
AUTO	4.00 Ω		0.21 Ω
Func	Lim		CAL

6. In case it was detected that the calibrated resistance is higher than the measured resistance increased by 0.05 Ω ($R_{CAL} > R_{MEAS} + 0.05 \Omega$), the instrument gives a long acoustic signal and displays a screen similar to the one reported here to the side

LOW Ω			
0.00 Ω			
R+		R-	
0.00 Ω		0.00 Ω	
214 mA		214 mA	
CAL > RES			
AUTO	4.00 Ω		0.21 Ω
Func	Lim		CAL

7. By using the CAL mode, if the instrument detects a resistance higher than 5 Ω at input leads, a screen similar to the one reported here to the side is displayed, and the instrument remains in the condition of no resistance calibrated

LOW Ω			
----- Ω			
R+		R-	
----- Ω		----- Ω	
--- mA		--- mA	
Reset value			
CAL	4.00 Ω		0.21 Ω
Func	Lim		CAL

8. By using the CAL mode, verifying the calibrated value at the end of the CAL procedure, if the condition: $R_{CAL} \leq R_{MEAS} \leq R_{CAL} + 0.05 \Omega$ is not met, a screen similar to the one reported here to the side is displayed, and the instrument remains in the condition of no resistance calibrated

LOW Ω			
1.98 Ω			
R+		R-	
1.98 Ω		1.98 Ω	
210 mA		210 mA	
Not correct			
CAL	4.00 Ω		---- Ω
Func	Lim		CAL

9.  The previous anomalous results cannot be saved

6.3. MΩ: MEASUREMENT OF THE INSULATION RESISTANCE

This function is performed according to standard IEC/EN61557-2 and allows measuring the insulation resistance between the active conductors and between each active conductor and the earth. The following operating modes are available:

- **MAN** in this mode, the test continues until the **GO/STOP** key on the instrument (or the **START** key on the remote probe) is held. If the **GO/STOP** key (or the **START** key of the remote probe) is pressed and immediately released, the test has a duration of 2 seconds. Recommended mode for insulation test
- **TMR** in this mode, the operator may set a measuring time long enough to be able to move the test lead onto the conductors being tested, while the instrument is performing the test. For the whole measurement duration, the instrument will give a short acoustic signal every 2 seconds (in order to have a stable reading of resistance, it is recommended to wait at least two acoustic signals before moving the test lead to another conductor). While measuring, if insulation resistance reaches a lower value than the set limit, the instrument will give a continuous acoustic signal. To stop the test, press the **GO/STOP** key on the instrument or the **START** key on the remote probe again.

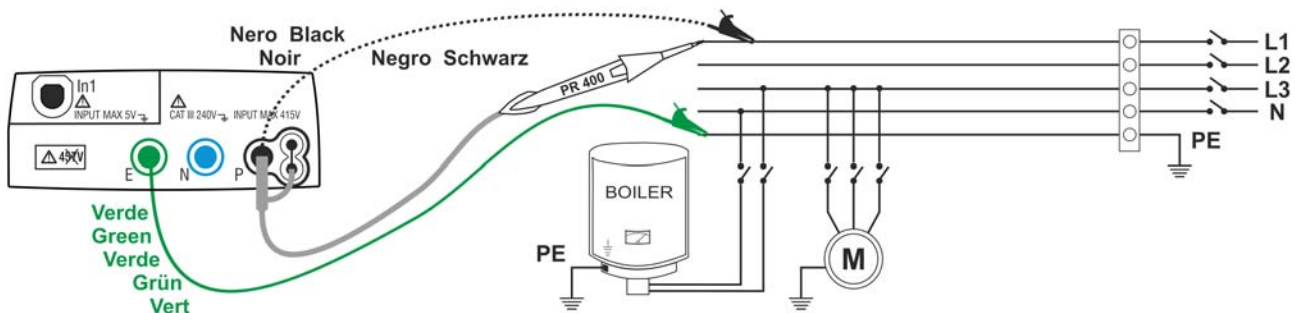

Fig. 8: Instrument connection by means of single cables and remote probe

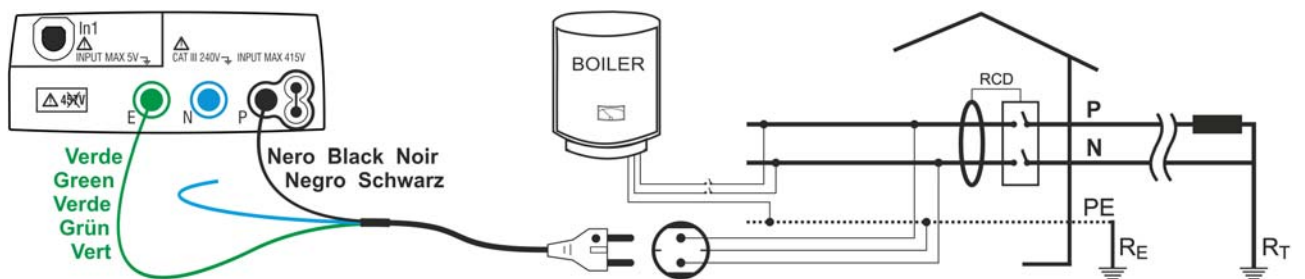
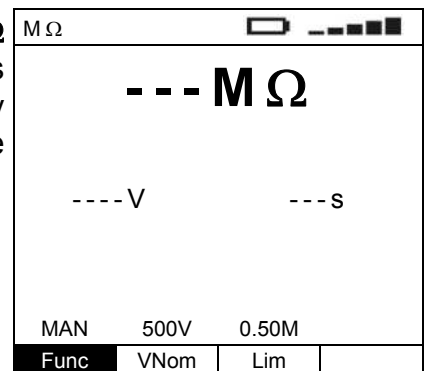



Fig. 9: Instrument connection through shuko cable

1.



Press the **MENU** key, move the cursor to **MΩ** in the main menu by means of the arrow keys (**▲**, **▼**) and confirm with **ENTER**. Subsequently the instrument displays a screen similar to the one reported here to the side.



2.  Use the ◀, ▶ keys to select the parameter to be modified, and the ▲, ▼ keys to modify the parameter value.
It is not necessary to confirm the selection with ENTER.

Func The virtual Func key allows setting the measuring mode of the instrument, which may be: **MAN, TMR**

VNom The virtual VNom key allows setting the test voltage, which may have the following values: **50V, 100V, 250V, 500V, 1000V**

Lim The virtual Lim key allows setting the minimum insulation limit, which may have the following values: **0.05MΩ, 0.10MΩ, 0.23MΩ, 0.25MΩ, 0.50MΩ, 1.00MΩ, 100MΩ**

Temp Only in TMR measuring mode, the virtual Temp key allows setting the test duration time that may range between **10** and **999 seconds**

3. We suggest setting the value of the voltage supplied while measuring and the minimum limit to consider the measure correct according to the prescriptions of the reference standard (§ 13.2).
4. Insert the green and black connectors of the single cables into the corresponding input leads E and P of the instrument. Apply the relevant alligator clips to the free ends of the cables. It is also possible to use the remote probe by inserting its multipolar connector into the input lead P.
5. Should the length of the cables provided be insufficient for the measurement to be performed, extend the green cable.

CAUTION



Before connecting the test leads, make sure that there is no voltage at the ends of the conductors to be tested. Disconnect any cable not strictly involved in measurement and moreover check that no cable is connected to In1 input.

6. Connect the test leads to the ends of the conductors to be tested as in Fig. 8 and Fig. 9.

7.  Press the **GO/STOP** key on the instrument or the **START** key on remote probe. The instrument will start the measurement.

CAUTION



If message "**Measuring...**" appears on the display, the instrument is performing measurement. During this whole stage, do not disconnect the test leads of the instrument from the conductors under test, as the circuit being tested could remain charged with a dangerous voltage due to the stray capacitances of the system

8. Regardless of the operating mode selected, the instrument, at the end of each test, applies a resistance to the output leads to discharge the stray capacitances in the circuit

9.  In case the **TMR** mode has been selected, pressing the **GO/STOP** key on the instrument or the **START** key on remote probe stops the test before the set time has elapsed.

10. Should the measured value be higher than the set limit, the instrument gives a double acoustic signal and displays the message "OK" which signals the positive result of the test and a screen similar to the one reported here to the side

M.Ω			
578 M Ω			
526 V		15 s	
OK			
MAN	500V	0.50M	15s
Func	VNom	Lim	Temp

Insulation resistance

Applied test voltage and test duration time

11. Should the measured value be higher than the full scale (§ 11.1), the instrument gives a double acoustic signal and displays the message "OK" which signals the positive result of the test and a screen similar to the one reported here to the side

M.Ω			
> 999 M Ω			
526 V		2 s	
OK			
MAN	500V	0.50M	
Func	VNom	Lim	

Insulation resistance

Applied test voltage and test duration time

12.  The results displayed can be saved by pressing the **SAVE** key twice or the **SAVE** key and, subsequently, the **ENTER** key (§ 8.1)

6.3.1. Description of anomalous results

1. Should the instrument not be able to generate the nominal voltage, at the end of the test, it gives a long acoustic signal and displays and a screen similar to the one reported here to the side

M.Ω			
0.01 M Ω			
64 V		6 s	
Not correct			
MAN	500V	0.50M	
Func	VNom	Lim	

2. If the measured insulation value is lower than the set limit, the instrument displays a screen similar to the one reported here to the side and gives a long acoustic signal

M.Ω			
0.19 M Ω			
526 V		2 s	
Not correct			
MAN	500V	0.50M	
Func	VNom	Lim	

3.  The results displayed can be saved by pressing the **SAVE** key twice or the **SAVE** key and, subsequently, the **ENTER** key (§ 8.1)

4. If the instrument detects a voltage of about 10V on the upper input leads, it displays the message reported here to the side and stops measurement

MΩ			
- - - M Ω			
- - - V		- - - s	
Vin > Vlim			
MAN	500V	0.50M	15s
Func	VNom	Lim	Temp

5.  The previous anomalous result cannot be saved

6.4. RCD: TEST ON A-TYPE AND AC-TYPE RCDS

This function is performed in compliance with standard IEC/EN61557-6 and allows measuring the tripping time and the current of the system's RCDs. The following operating modes are available:

- **AUTO** the instrument performs measurement automatically with a leakage current equal to half, once or five times the set value of nominal current and with a leakage current in phase with the positive and negative half-wave of the mains voltage. Recommended mode for RDC test
- **x $\frac{1}{2}$** the instrument performs measurement with a leakage current equal to half the set value of nominal current
- **x1** the instrument performs measurement with a leakage current equal to once the set value of nominal current
- **x2** the instrument performs measurement with a leakage current equal to twice the set value of nominal current
- **x5** the instrument performs measurement with a leakage current equal to five times the set value of nominal current
- the instrument performs measurement with an increasing leakage current. This test could be performed to determine the real tripping current of the RCD
- **RA** the instrument performs measurement with a leakage current equal to half the set value of nominal current in order not to trip the RCD and measuring the contact voltage and the total earth resistance.

CAUTION



Testing an RCD causes the RCD's tripping. Therefore, check that there are **NO users or loads connected downstream of the RCD being tested which could be damaged by a system downtime.**

If possible, disconnect all loads connected downstream of the RCD as they could produce leakage currents further to those produced by the instrument, thus invalidating the results of the test.

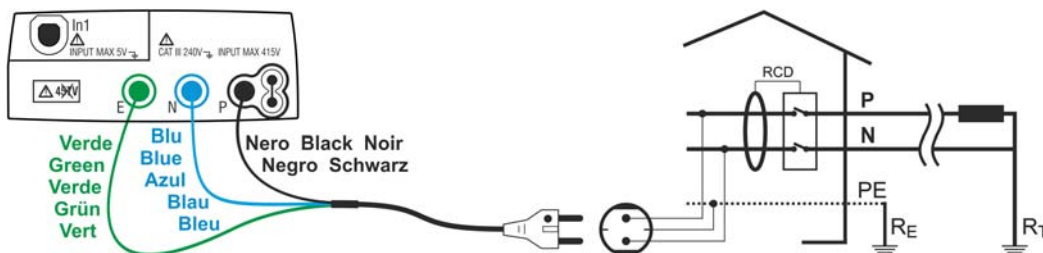

Fig. 10: Instrument connection for 230V single-phase or double-phase RCD test through shuko cable

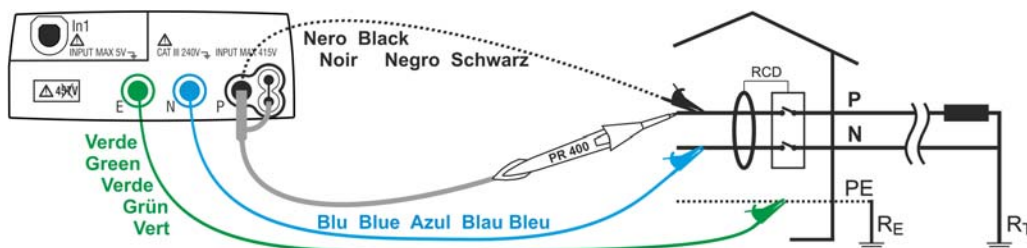

Fig. 11: Instrument connection for 230V single-phase or double-phase RCD test by means of single cables and remote probe

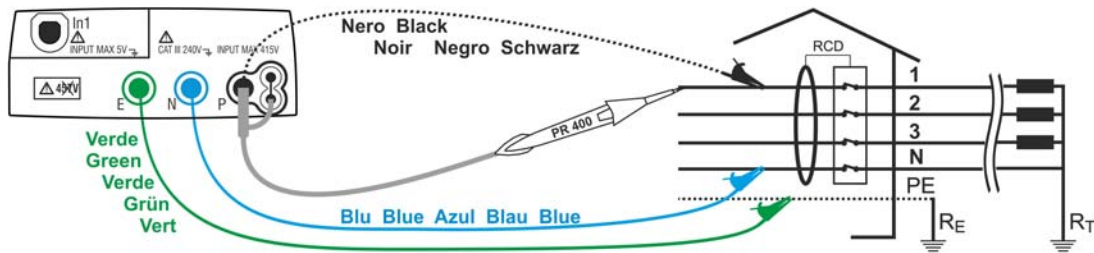

Fig. 12: Instrument connection for 400V + N + PE three-phase RCD test by means of single cables and remote probe

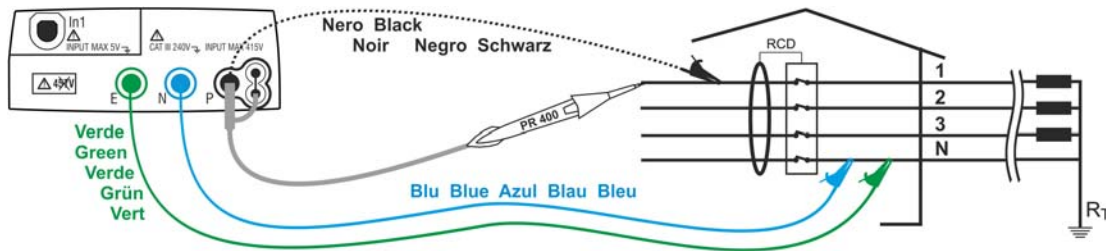

Fig. 13: Instrument connection for 400V + N (no PE) three-phase RCD test by means of single cables and remote probe

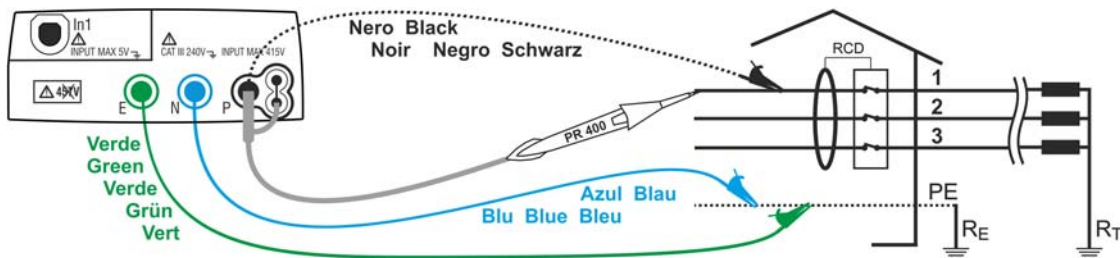

Fig. 14: Instrument connection for 400V + PE (no N) three-phase RCD test by means of single cables and remote probe

1.



Press the **MENU** key, move the cursor to **RCD** in the main menu by means of the arrow keys (**▲**, **▼**) and confirm with **ENTER**. Subsequently the instrument displays a screen similar to the one reported here to the side.

RCD				0°	
---ms					
FRQ=50.0Hz		Ut=0.0V			
VP-N=230V		VP-Pe=230V			
x1	30mA	~	50V		
Func	IdN	RCD	UL		

2.



Use the **◀**, **▶** keys to select the parameter to be modified, and the **▲**, **▼** keys to modify the parameter value.

It is not necessary to confirm the selection with ENTER.

Func The virtual Func key allows setting the measuring mode of the instrument, which may be: **AUTO**, **x1/2**, **x1**, **x2**, **x5**, **▲**, **RA**

IdN The virtual IdN key allows setting the nominal value of the RCD's tripping current, which may be: **10mA**, **30mA**, **100mA**, **300mA**, **500mA**, **650mA**, **1A**

RCD The virtual RCD key enables the selection of the RCD type, which may be: **AC**, **AC S**, **A**, **A S** (the options A, A **S** are not available if the electrical system set is IT)

UL The virtual UL key allows setting the limit value of contact voltage for the system being tested, which may be: **25V**, **50V**

3. Should you have any doubt regarding the correct value, we suggest setting the limit value for contact voltage to 25V, as it is the lowest limit (for safety reasons).
4. Insert the green, blue and black connectors of the three-pin shuko cable into the corresponding input leads E, N and P of the instrument. As an alternative, use the single cables and apply the relevant alligator clips to the free ends of the cables. It is also possible to use the remote probe by inserting its multipolar connector into the input lead P. Connect the shuko plug, the alligator clips or the remote probe to the electrical mains according to Fig. 10, Fig. 11, Fig. 12, Fig. 13 and Fig. 14.

6.4.1. AUTO mode

5.  Press the **GO/STOP** key on the instrument or the **START** key on remote probe. The instrument will start the measurement.
6. The instrument performs the following six tests referred to nominal current:
 - $I_{dN} \times \frac{1}{2}$ with 0° phase (the RCD must not trip)
 - $I_{dN} \times \frac{1}{2}$ with 180° phase (the RCD must not trip)
 - $I_{dN} \times 1$ with 0° phase (the RCD must trip, reset the switch)
 - $I_{dN} \times 1$ with 180° phase (the RCD must trip, reset the switch)
 - $I_{dN} \times 5$ with 0° phase (the RCD must trip, reset the switch)
 - $I_{dN} \times 5$ with 180° phase (the RCD must trip, end of test).
7. The test has a positive result if all tripping times comply with what indicated in Table 5. The test has a negative result when one of the value is out of range.

CAUTION



If message "**Measuring...**" appears on the display, the instrument is performing measurement. During this whole stage, do not disconnect the test leads of the instrument from the mains.

5. The "AUTO" test is not available for 500mA, 650mA and 1A A-type  RCDs.

6. While performing the test, the instrument supplies a leakage voltage according to the multiplier and to the phase indicated on the display. From the third test on, the RCD should trip and, subsequently, the operator will have to reset it

RCD			
	0°	180°	
x 1/2	>999ms	>999ms	
x 1	28ms	---	ms
x 5	---	---	ms
FRQ=50.0Hz		Ut=1.4V	
VP-N=228V		VP-Pe=228V	
RESUME RCD			
AUTO	30mA		50V
Func	IdN	RCD	UL

Tripping times of the RCD at the different currents provided for in the test

The operator is asked to resume the RCD

7. Once test is completed, in case all six tests have had a positive result, the instrument displays a screen similar to the one reported here to the side

RCD			
	0°	180°	
x 1/2	>999ms	>999ms	
x 1	28ms	31ms	
x 5	8ms	10ms	
FRQ=50.0Hz		Ut=1.4V	
VP-N=228V		VP-Pe=228V	
RCD OK			
AUTO	30mA		50V
Func	IdN	RCD	UL

Tripping times (expressed in ms)

8.  The results displayed can be saved by pressing the **SAVE** key twice or the **SAVE** key and, subsequently, the **ENTER** key (§ 8.1)

6.4.2. x^{1/2} mode

As an alternative:

5.



Press the **GO/STOP** key on the instrument or the **START** key on the remote probe once. The instrument will start measuring with a “0°” type current, injecting a current in phase with the positive half-wave of voltage.

Or:

5.



Press the **GO/STOP** key on the instrument twice or the **START** key on the remote probe before the hyphens disappear. The instrument will start measuring with a “180°” type current, injecting a current in phase with the negative half-wave of voltage.

CAUTION



If message “**Measuring...**” appears on the display, the instrument is performing measurement. During this whole stage, do not disconnect the test leads of the instrument from the mains.

6. If the RCD does not trip, the instrument gives a double acoustic signal which signals the positive result of the test and then displays a screen similar to the one reported here to the side

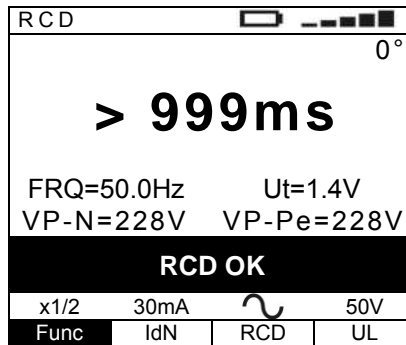

0° or 180° type current

Tripping time of the RCD

Detected value for contact voltage Ut compared to the nominal value of the set residual current

7. The results displayed can be saved by pressing the **SAVE** key twice or the **SAVE** key and, subsequently, the **ENTER** key (§ 8.1)

6.4.3. x1, x2, x5 mode

As an alternative:

5. Press the **GO/STOP** key on the instrument or the **START** key on the remote probe once. The instrument will start measuring with a “0°” type current, injecting a current in phase with the positive half-wave of voltage.

Or:

5. Press the GO/STOP key on the instrument twice or the START key on the remote probe before the hyphens disappear. The instrument will start measuring with a “180°” type current, injecting a current in phase with the negative half-wave of voltage.

CAUTION



If message “**Measuring...**” appears on the display, the instrument is performing measurement. During this whole stage, do not disconnect the test leads of the instrument from the mains.

6. The “x5” test is not available for 500mA, 650mA and 1A A-type RCDs

7. When the RCD trips and separates the circuit, if the tripping time is within the limits reported in Table 5, the instrument gives a double acoustic signal which signals the positive result of the test and then displays a screen similar to the one reported here to the side

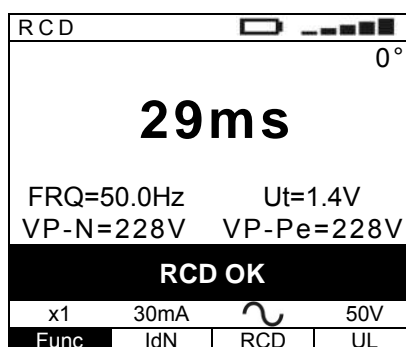

0° or 180° type current

Tripping time of the RCD

Detected value for contact voltage Ut compared to the nominal value of the set residual current

8. The results displayed can be saved by pressing the **SAVE** key twice or the **SAVE** key and, subsequently, the **ENTER** key (§ 8.1)

6.4.4. mode

The standard defines the tripping times for RCDs at nominal current. The mode is used to detect the tripping time at tripping current (which could also be lower than the nominal voltage).

As an alternative:

5. Press the **GO/STOP** key on the instrument or the **START** key on remote probe once. The instrument will start measuring with a “0°” type current, injecting a current in phase with the positive half-wave of voltage.

Or:

5. Press the GO/STOP key on the instrument twice or the START key on the remote probe before the hyphens disappear. The instrument will start measuring with a “180°” type current, injecting a current in phase with the negative half-wave of voltage

CAUTION



If message “**Measuring...**” appears on the display, the instrument is performing measurement. During this whole stage, do not disconnect the test leads of the instrument from the mains.

6. According to standard EN61008, the test for selective RCDs requires an interval of 60 seconds between the tests. **The mode is therefore unavailable for selective RCDs, both of A and of AC type.**

7. While performing the test, the instrument supplies an increasing leakage voltage and displays a screen similar to the one reported here to the side

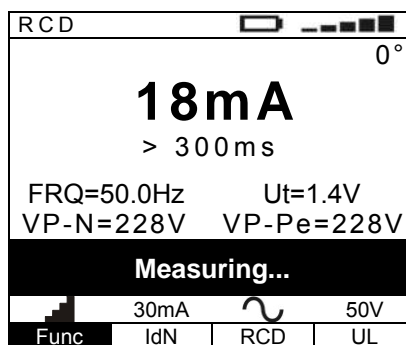

0° or 180° type current

Test current

the RCD under test did not trip at the displayed test current

8. When the RCD trips and separates the circuit, if the tripping time and current is within the limits reported in Table 5, the instrument gives a double acoustic signal which signals the positive result of the test and then displays a screen similar to the one reported here to the side

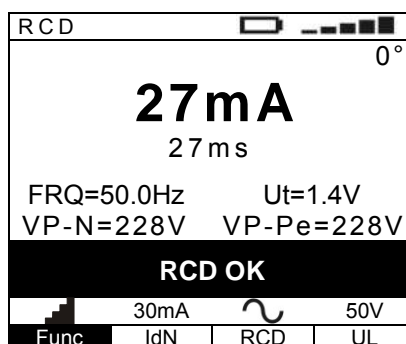

0° or 180° type current

Tripping current of the RCD

Tripping time at the tripping current of the RCD under test

9. The results displayed can be saved by pressing the **SAVE** key twice or the **SAVE** key and, subsequently, the **ENTER** key (§ 8.1)

6.4.5. RA mode

In RA mode, the contact voltage and the total earth resistance are measured by supplying a leakage voltage equal to half the value of the set nominal current in order to prevent the RCD from tripping.

5.  Press the **GO/STOP** key on the instrument or the **START** key on remote probe. The instrument will start the measurement.



CAUTION

If message “**Measuring...**” appears on the display, the instrument is performing measurement. During this whole stage, do not disconnect the test leads of the instrument from the mains.

6. After the test is completed, if the measured resistance value matches the nominal current and the set limit contact voltage, $RA < UI/IdN$ (1666Ω @ $UL=50V$ and $IdN=30mA$), the instrument gives a double acoustic signal and displays the message “OK”, which

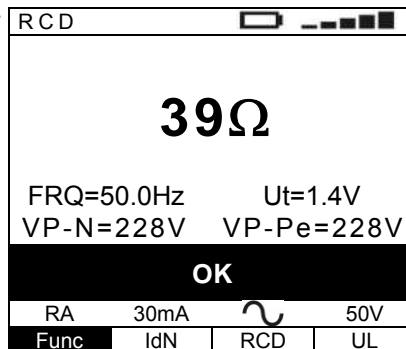

Value of total earth resistance

Detected value for contact voltage U_t compared to the nominal value of the set residual current

signals that the test has been completed successfully, and displays a screen similar to the one reported here to the side

7.  The results displayed can be saved by pressing the **SAVE** key twice or the **SAVE** key and, subsequently, the **ENTER** key (§ 8.1)

6.4.6. Description of anomalous results

1. By using the RA mode, if the instrument detects a contact voltage higher than the set limit, it displays the message reported here to the side. Check the efficiency of the protective conductor and the earthing

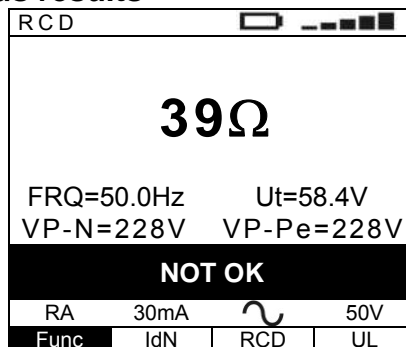

Dangerous contact voltage

2. If the RCD trips in a time exceeding the limits reported in Table 5, the instrument gives a long acoustic signal which signals the negative result of the test and then displays a screen similar to the one reported here to the side. Check that the set type of RCD matches the type of RCD being tested

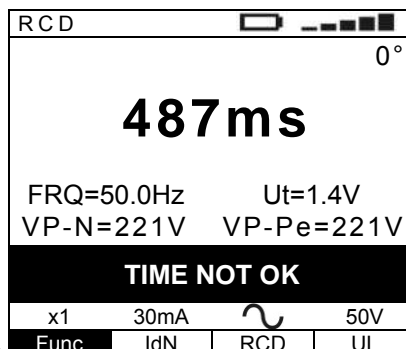

The tripping time is not compliant with Table 5

3. If the RCD does not trip within the maximum duration of the test, the instrument gives a long acoustic signal which signals the negative result of the test and then displays a screen similar to the one reported here to the side. Check that the set type of RCD matches the type of RCD being tested

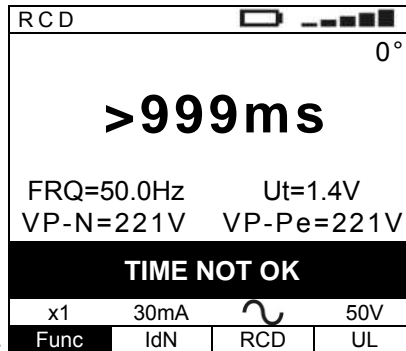

The RCD did not trip within the maximum duration of the test

4. If the selective RCD trips in a time lower than the minimum limit reported in Table 5, the instrument gives a long acoustic signal which signals the negative result of the test and then displays a screen similar to the one reported here to the side. Check that the set type of RCD matches the type of RCD being tested

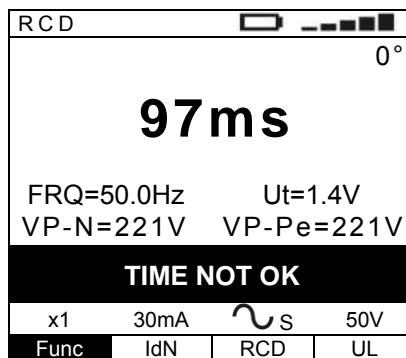

The tripping time is not compliant with Table 5

5. If, during a test in mode, the RCD trips in a time exceeding the maximum duration time provided for the test, the instrument gives a long acoustic signal which signals the negative result of the test and then displays a screen similar to the one reported here to the side

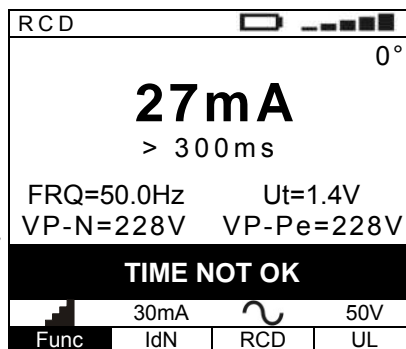

The tripping time is not conform

6. If, during a test in mode, the RCD does not trip, the instrument gives a long acoustic signal which signals the negative result of the test and then displays a screen similar to the one reported here to the side

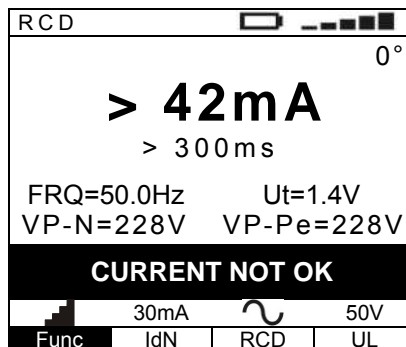

The tripping time is not conform

- 7.



The results displayed can be saved by pressing the **SAVE** key twice or the **SAVE** key and, subsequently, the **ENTER** key (§ 8.1)

8. If the instrument detects that the phase and neutral leads are inverted, the message reported here to the side is displayed. Rotate the shuko plug or check the connection of the single cables

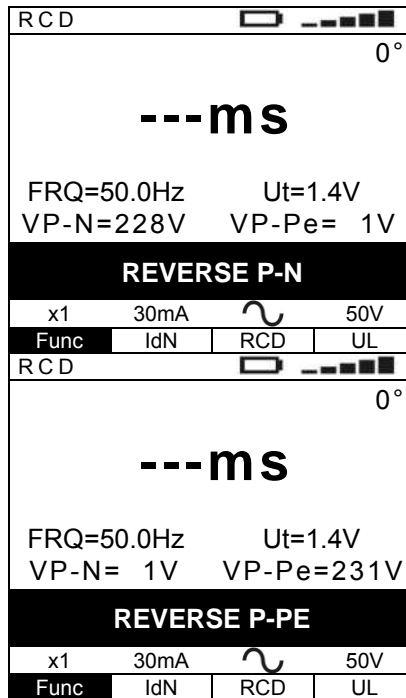

The phase and neutral conductors are inverted

9. If the instrument detects that the phase and earth leads are inverted, the message reported here to the side is displayed. Check the connection of the cables

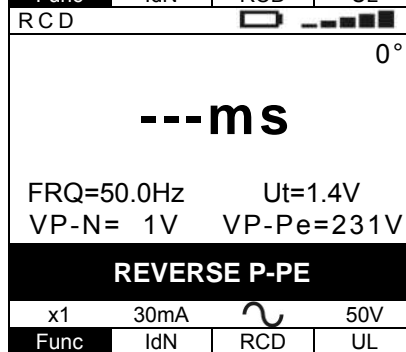

The phase and earth conductors are inverted

10. If the instrument detects a phase-to-neutral voltage and a phase-to-earth voltage lower than the limit, the message reported here to the side is displayed. Check that the system being tested is energized

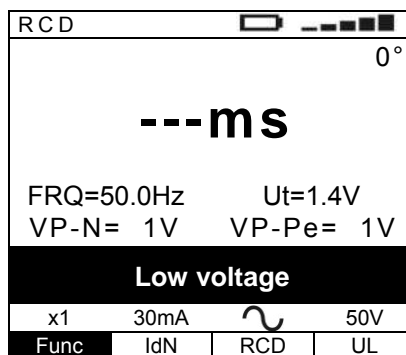

Insufficient voltage

11. If the instrument detects a phase-to-neutral voltage or a phase-to-earth voltage higher than the limit, the message reported here to the side is displayed. Check that the instrument is not phase-to-phase connected

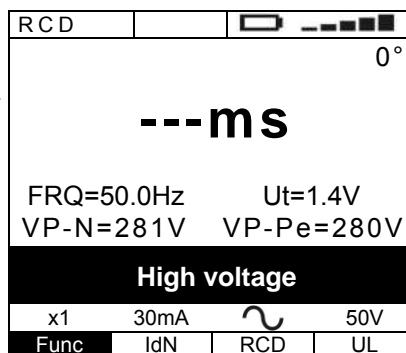

High voltage detected

12. If the instrument detects a phase-to-neutral voltage lower than the minimum limit, it does not perform the test and displays the message reported here to the side. Check the efficiency of the neutral conductor

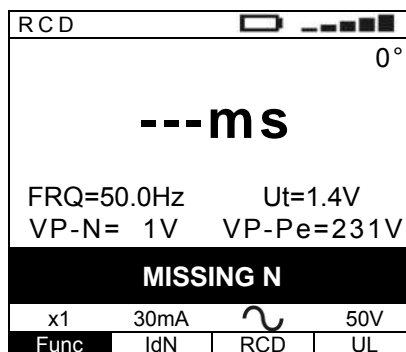

Missing neutral conductor

13. If the instrument detects an extremely high earth resistance, so that it deems the earth conductor or the earthing absent, it does not perform the test and displays the message reported here to the side. Check the efficiency of the protective conductor and the earthing

RCD			
0°			
---ms			
FRQ=50.0Hz		Ut=1.4V	
VP-N=231V		VP-Pe=160V	
MISSING-PE			
x1	30mA		50V
Func	IdN	RCD	UL

Inefficient earthing

14. If the instrument detects that, in case the test should be performed, a contact voltage higher than the set limit would build up in the system being tested, it does not perform the test and displays the message reported here to the side. Check the efficiency of the protective conductor and the earthing

RCD			
0°			
---ms			
FRQ=50.0Hz		Ut=0.0V	
VP-N=231V		VP-Pe=231V	
Ut > Ulim			
x1	30mA		50V
Func	IdN	RCD	UL

The instrument detects a dangerous contact voltage

15. If the RCD trips while performing the preliminary checks (automatically performed by the instrument before performing the selected test), the instrument displays the message reported here to the side. Check that all loads connected downstream of the RCD being tested are disconnected and that the set value for IdN matches the RCD being tested

RCD			
0°			
---ms			
FRQ=50.0Hz		Ut=0.0V	
VP-N=231V		VP-Pe=231V	
RCD TRIPPED			
x1	30mA		50V
Func	IdN	RCD	UL

RCD tripped during preliminary checks

16. If, after repeated tests, the instrument has overheated, the message reported here to the side is displayed. Wait for this message to disappear before performing other tests

RCD			
0°			
---ms			
FRQ=50.0Hz		Ut=1.4V	
VP-N=231V		VP-Pe=231V	
Hot temperature			
x1	30mA		50V
Func	IdN	RCD	UL

Overheated instrument

- 17.



The previous anomalous results cannot be saved

6.5. LOOP: MEASUREMENT OF LINE/LOOP IMPEDANCE

This function is performed according to standard IEC/EN61557-3 and allows measuring the line impedance, the earth fault loop impedance and the prospective short circuit current. The following operating modes are available:

- **P-N** the instrument measures impedance between the phase conductor and the neutral conductor and calculates the prospective phase-to-neutral short circuit current
- **P-P** the instrument measures impedance between two phase conductors and calculates the prospective phase-to-phase short circuit current
- **P-PE** the instrument measures the fault loop impedance and calculates the prospective fault current

CAUTION



The measurement of line impedance or fault loop impedance involves the circulation of a maximum current according to the technical specifications of the instrument (§ 11.1). This could cause the tripping of possible magnetothermal or differential protections at lower tripping currents.

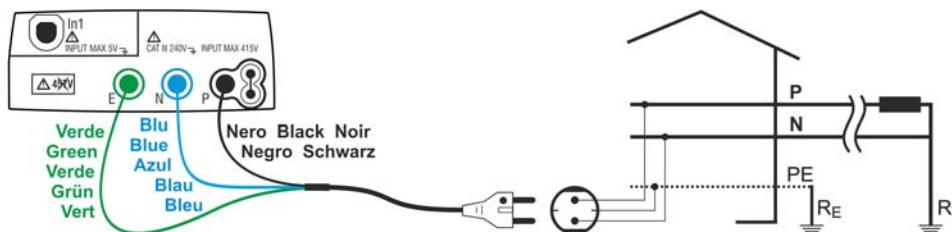

Fig. 15: Instrument connection for 230V single-phase or double-phase P-N line impedance and P-PE fault loop impedance measurement through shuko cable

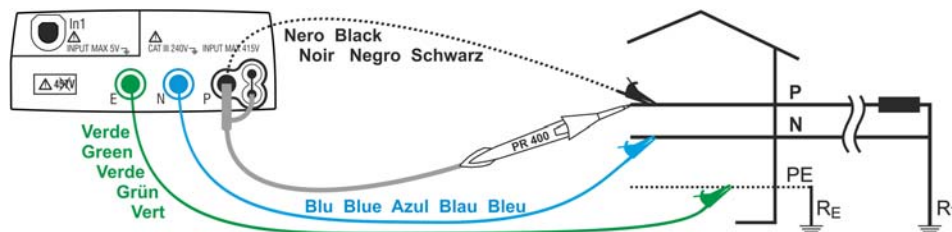

Fig. 16: Instrument connection for 230V single-phase or double-phase P-N line impedance and P-PE fault loop impedance measurement through single cables and remote probe

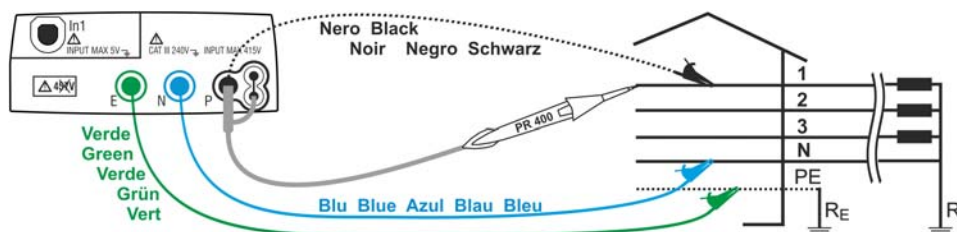

Fig. 17: Instrument connection for 400V + N + PE three-phase P-N line impedance and P-PE fault loop impedance measurement through single cables and remote probe

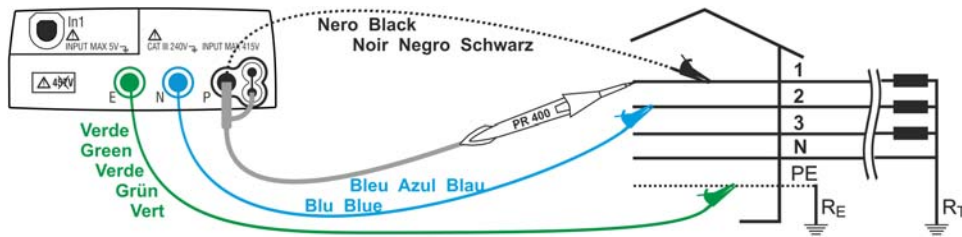

Fig. 18: Instrument connection for 400V + N + PE three-phase P-P line impedance measurement by means of single cables and remote probe

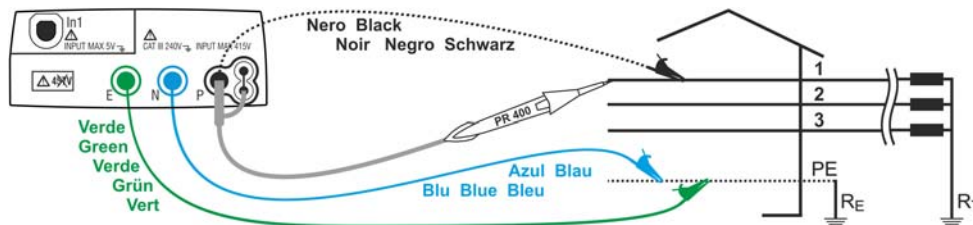
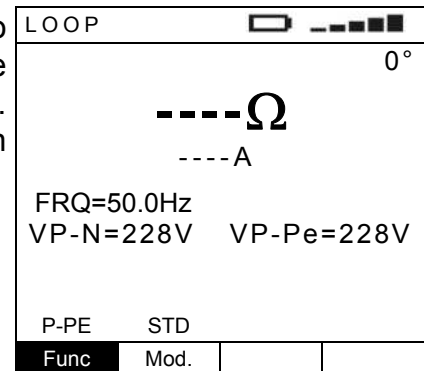

Fig. 19: Instrument connection for 400V + PE (no N) three-phase P-PE fault loop impedance measurement through single cables and remote probe

1.



Press the **MENU** key, move the cursor to **LOOP** in the main menu by means of the arrow keys (**▲**, **▼**) and confirm with **ENTER**. Subsequently the instrument displays a screen similar to the one reported here to the side.



2.



Use the **◀**, **▶** keys to select the parameter to be modified, and the **▲**, **▼** keys to modify the parameter value.

It is not necessary to confirm the selection with ENTER.

Func The virtual Func key allows setting the measuring mode of the instrument, which may be: **P-N**, **P-P**, **P-PE**

UL The virtual UL key, active only when an IT electrical system and the P-PE mode have been set (§ 5.2.5), allows setting the limit value of contact voltage for the system being tested, which may be: **50V**, **25V**

Mod. The virtual UL key, not active when an IT electrical system and the P-PE mode have been set (§ 5.2.5), allows setting the instrument's operating mode, which can be: **STD**, **Z2Ω**

ICAL The virtual ICAL key, active only when the Z2Ω mode has been selected with the MOD key, allows selecting the assumed short-circuit or fault current displayed. Following values are available: **IkMax3Ph**, **IkMin3Ph**, **IkMax2Ph**, **IkMin2Ph**, **IkMaxP-N**, **IkMinP-N**, **IkMaxP-PE**, **IkMinP-PE**, **IkSTD**

RMT The virtual RMT key, active only when the Z2Ω mode has been selected with the MOD key, displays the serial number and the FW version of the remote unit IMP57

- If possible, disconnect all loads connected downstream of the measured point, as the impedance of these users could distort the test results.
- Use the virtual Mod. key to set the STD test mode. Should you perform high-resolution tests, recommended near MT/BT transformers, we suggest using the Z2Ω mode, which implies the use of the optional accessory IMP57. Upon the selection of the Z2Ω mode, the instrument displays a screen similar to the one reported here to the side. Connect accessory IMP57 to the instrument by means of the serial optical cable and perform the measurements as described in the relevant user manual.
- Insert the green, blue and black connectors of the three-pin shuko cable into the corresponding input leads E, N and P of the instrument. As an alternative, use the single cables and apply the relevant alligator clips to the free ends of the cables. It is also possible to use the remote probe by inserting its multipolar connector into the input lead P. Connect the shuko plug, the alligator clips or the remote probe to the electrical mains according to Fig. 15, Fig. 16, Fig. 17, Fig. 18 and Fig. 19.

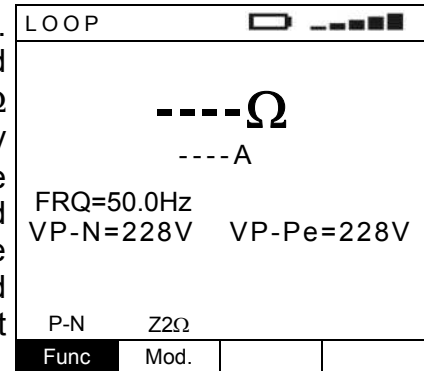

6.5.1. P-N mode

-  Press the **GO/STOP** key on the instrument or the **START** key on remote probe. The instrument will start the measurement.

CAUTION



If message “**Measuring...**” appears on the display, the instrument is performing measurement. During this whole stage, do not disconnect the test leads of the instrument from the mains.

- Once test is completed, if the measured impedance value is lower than the full scale, the instrument gives a double acoustic signal and then displays a screen similar to the one reported here to the side

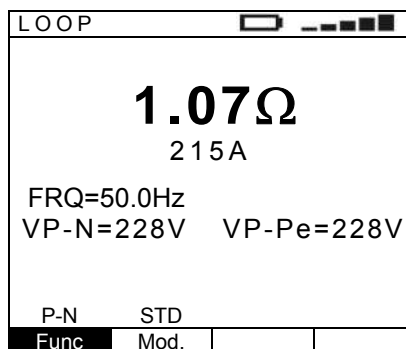

Measured impedance value
Prospective short circuit current
P-N and P-PE measured voltages

8. Formula used for calculating the prospective short circuit current: $I_{CC} = \frac{U_N}{Z_{PN}}$

where: Z_{PN} is the measured phase-to-neutral impedance

U_N is the nominal phase-to-neutral voltage

$U_N = 127V$ if $V_{P-N\text{ meas}} \leq 150V$

$U_N = 230V$ or $U_N = 240V$ (§ 5.2.3) if $V_{P-N\text{ meas}} > 150V$

9.  The results displayed can be saved by pressing the **SAVE** key twice or the **SAVE** key and, subsequently, the **ENTER** key (§ 8.1)

6.5.2. P-P mode

6.  Press the **GO/STOP** key on the instrument or the **START** key on remote probe. The instrument will start the measurement.

CAUTION



If message "**Measuring...**" appears on the display, the instrument is performing measurement. During this whole stage, do not disconnect the test leads of the instrument from the mains.

7. Once test is completed, if the measured impedance value is lower than the full scale, the instrument gives a double acoustic signal and then displays a screen similar to the one reported here to the side

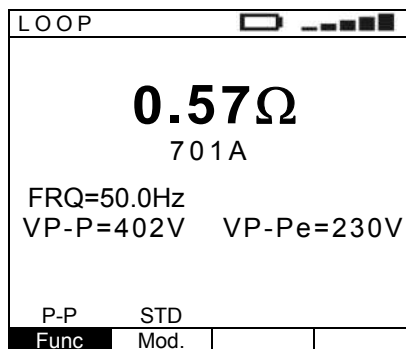

Measured impedance value

Prospective short circuit current

P-P and P-PE measured voltages

8. Formula used for calculating the prospective short circuit current: $I_{CC} = \frac{U_N}{Z_{PP}}$

where: Z_{PP} is the measured phase-to-phase impedance

U_N is the nominal phase-to-phase voltage

$U_N = 127V$ if $V_{P-P\text{ meas}} \leq 150V$

$U_N = 230V$ or $U_N = 240V$ (§ 5.2.3) if $150V < V_{P-P\text{ meas}} \leq 265V$

$U_N = 400V$ or $U_N = 415V$ (§ 5.2.3) if $V_{P-P\text{ meas}} > 265V$

9.  The results displayed can be saved by pressing the **SAVE** key twice or the **SAVE** key and, subsequently, the **ENTER** key (§ 8.1)

6.5.3. P-PE mode in TT or TN systems

As an alternative:



Press the **GO/STOP** key on the instrument or the **START** key on remote probe once. The instrument will start measuring with a “0°” type current, injecting a current in phase with the positive half-wave of voltage

Or:



Press the **GO/STOP** key on the instrument twice or the **START** key on the remote probe before the hyphens disappear. The instrument will start measuring with a “180°” type current, injecting a current in phase with the negative half-wave of voltage

CAUTION



If message “**Measuring...**” appears on the display, the instrument is performing measurement. During this whole stage, do not disconnect the test leads of the instrument from the mains.

7. Once test is completed, if the measured impedance value is lower than the full scale, the instrument gives a double acoustic signal and then displays a screen similar to the one reported here to the side

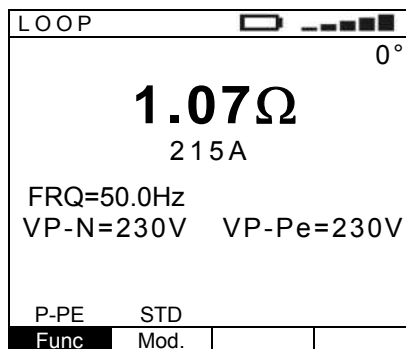

0° or 180° type current

Measured impedance value

Prospective short circuit current

P-P and P-PE measured voltages

8. Formula used for calculating the prospective fault current: $I_{CC} = \frac{U_N}{Z_{PE}}$

where: Z_{PE} is the measured fault impedance

U_N is the nominal phase-to-earth voltage

$U_N = 127V$ if $V_{P-PE\ meas} \leq 150V$

$U_N = 230V$ or $U_N = 240V$ (§ 5.2.3) if $V_{P-PE\ meas} > 150V$

9. In TT systems, the impedance value measured by the instrument may only be referred to the value of the total earth resistance. Therefore, in compliance with the prescriptions of standard CEI64-8, the measured value may be taken as the value for the system's earth resistance

10. The results displayed can be saved by pressing the **SAVE** key twice or the **SAVE** key and, subsequently, the **ENTER** key (§ 8.1)

9. By using the P-PE mode, if the instrument detects that, in case the test should be performed, a contact voltage higher than the set limit would build up in the system being tested, it does not perform the test and displays the message reported here to the side. Check the efficiency of the protective conductor and the earthing

LOOP		0°	
--- Ω --- A			
FRQ=50.0Hz			
VP-N=231V		VP-Pe=231V	
Ut > Ulim			
P-PE	STD		
Func	Mod.		

Dangerous contact voltage

10. If, after repeated tests, the instrument has overheated, the message reported here to the side is displayed. Wait for this message to disappear before performing other tests

LOOP		0°	
--- Ω --- A			
FRQ=50.0Hz			
VP-N=231V		VP-Pe=231V	
Hot temperature			
P-N	STD		
Func	Mod.		

Overheated instrument

11.  The previous anomalous results cannot be saved

6.6. R_A: MEASUREMENT OF THE TOTAL EARTH RESISTANCE THROUGH THE SOCKET-OUTLET

This function is performed in compliance with standards IEC/EN61557-6 and allows measuring the impedance of the fault loop, comparable to the overall earth resistance in TT systems. One single operating mode is available.



CAUTION

The measurement of the overall earth resistance involves the circulation of a current between phase and earth according to the technical specifications of the instrument (§ 11.1). This could cause the tripping of possible protections at lower tripping currents.

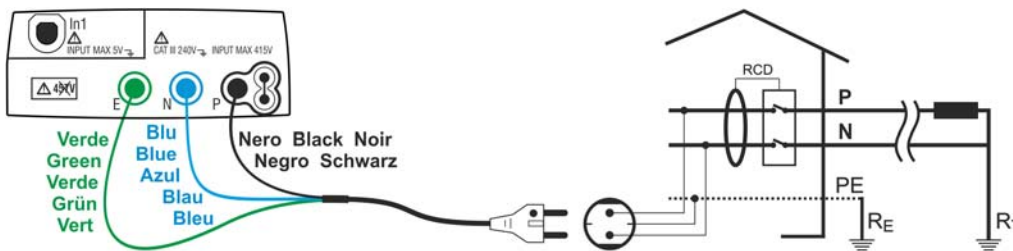

Fig. 20: Instrument connection for 230V single-phase or double-phase P-PE fault loop impedance measurement through shuko cable

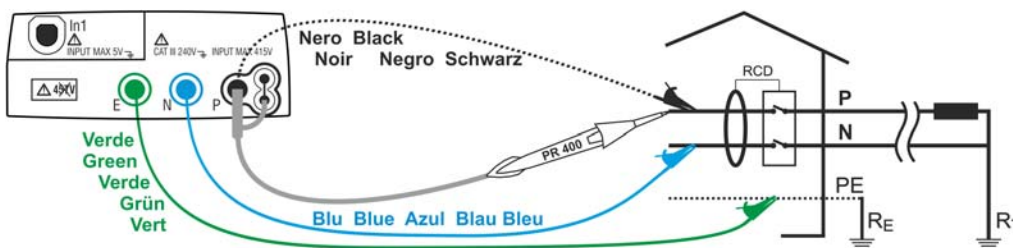

Fig. 21: Instrument connection for 230V single-phase or double-phase P-PE fault loop impedance measurement through single cables and remote probe

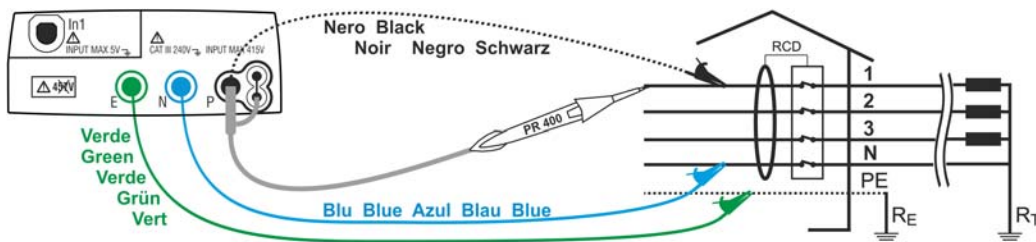

Fig. 22: Instrument connection for 400V + N + PE three-phase P-PE fault loop impedance measurement through single cables and remote probe

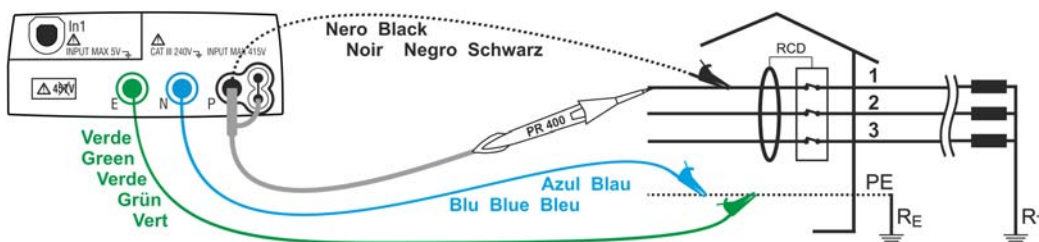

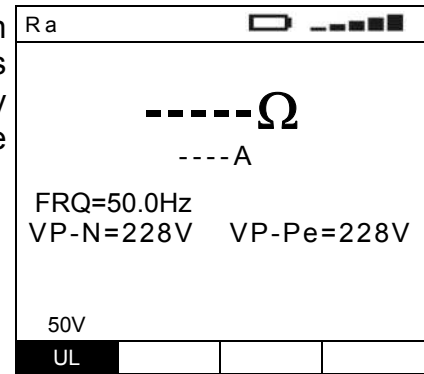



Fig. 23: Instrument connection for 400V + PE (no N) three-phase P-PE fault loop impedance measurement through single cables and remote probe

- 

Press the **MENU** key, move the cursor to **Ra** in the main menu by means of the arrow keys (**▲**, **▼**) and confirm with **ENTER**. Subsequently the instrument displays a screen similar to the one reported here to the side.



- 

Use the arrow keys **▲**, **▼** to set the limit value of contact voltage for the system being tested, which may be: **50V**, **25V**.
It is not necessary to confirm the selection with ENTER.
- If possible, disconnect all loads connected downstream of the measured point, as the impedance of these users could distort the test results.
- Insert the green, blue and black connectors of the three-pin shuko cable into the corresponding input leads E, N and P of the instrument. As an alternative, use the single cables and apply the relevant alligator clips to the free ends of the cables. It is also possible to use the remote probe by inserting its multipolar connector into the input lead P. Connect the shuko plug, the alligator clips or the remote probe to the electrical mains according to Fig. 20, Fig. 21, Fig. 22 and Fig. 23.
- 

Press the **GO/STOP** key on the instrument or the **START** key on remote probe. The instrument will start the measurement.

CAUTION



If message "**Measuring...**" appears on the display, the instrument is performing measurement. During this whole stage, do not disconnect the test leads of the instrument from the mains.

- Once test is completed, if the measured impedance value is lower than the full scale, the instrument gives a double acoustic signal and then displays a screen similar to the one reported here to the side

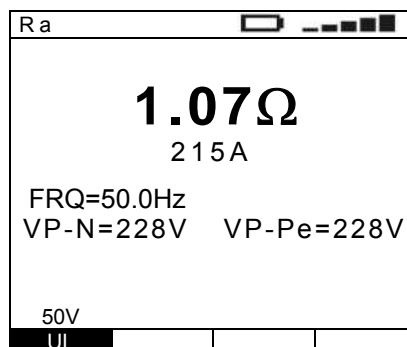

Measured impedance value

Prospective fault current

P-N and P-PE measured voltages

5. If the instrument detects that the phase and earth leads are inverted, the message reported here to the side is displayed. Check the connection of the cables

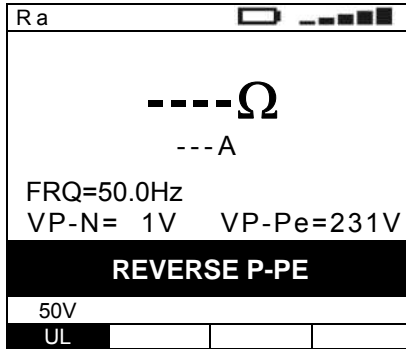

The phase and earth conductors are inverted

6. If the instrument detects a phase-to-neutral voltage and a phase-to-earth voltage lower than the limit, the message reported here to the side is displayed. Check that the system being tested is energized

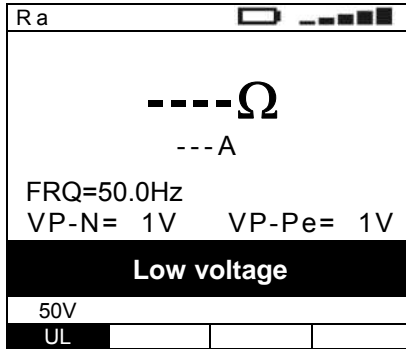

Insufficient voltage

7. If the instrument detects a phase-to-neutral voltage or a phase-to-earth voltage higher than the limit, the message reported here to the side is displayed. Check that the instrument is not phase-to-phase connected

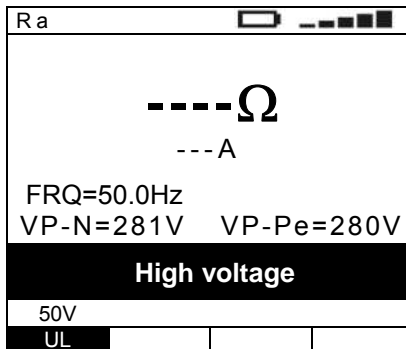

High voltage detected

8. If the instrument detects a phase-to-neutral voltage lower than the minimum limit, it does not perform the test and displays the message reported here to the side. Check the efficiency of the neutral conductor

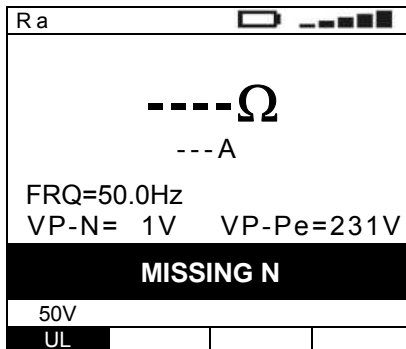

Missing neutral conductor

9. If the instrument detects an extremely high earth resistance, so that it deems the earth conductor or the earthing absent, it does not perform the test and displays the message reported here to the side. Check the efficiency of the protective conductor and the earthing

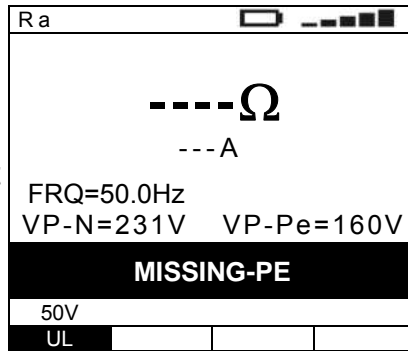

Inefficient earthing

10. If the instrument detects that, in case the test should be performed, a contact voltage higher than the set limit would build up in the system being tested, it does not perform the test and displays the message reported here to the side. Check the efficiency of the protective conductor and the earthing

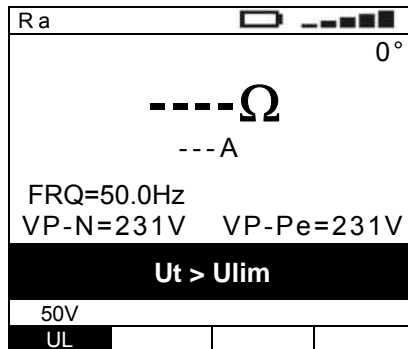

Dangerous contact voltage

11. If, after repeated tests, the instrument has overheated, the message reported here to the side is displayed. Wait for this message to disappear before performing other tests

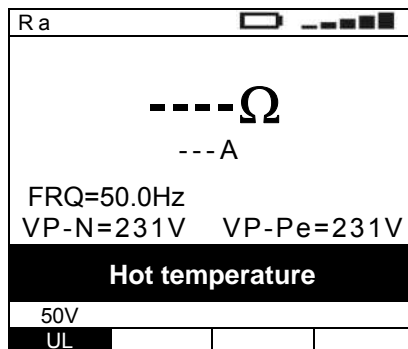

Overheated instrument

12.  The previous anomalous results cannot be saved

6.7. 123: PHASE SEQUENCE TEST

This function is performed in compliance with standards IEC/EN61557-7 and allows testing the phase sequence by direct contact with parts under voltage (no cables with insulating sheath). The following operating modes are available:

- **1T** one test lead mode
- **2T** two test leads mode.

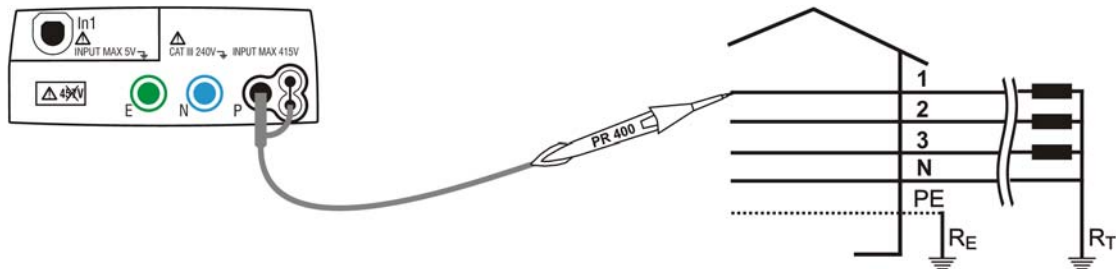

Fig. 24: Instrument connection for measuring the phase sequence with one lead, phase 1 connection

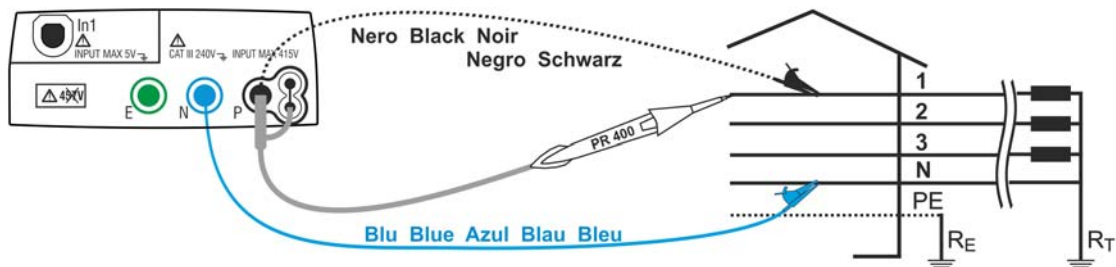

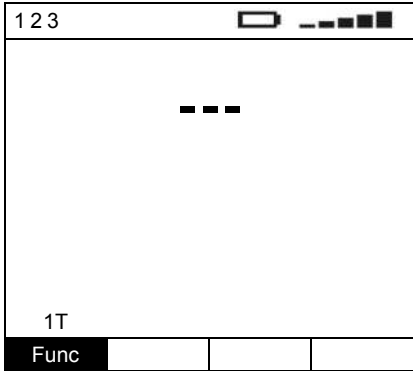



Fig. 25: Instrument connection for measuring the phase sequence with two leads, phase 1 connection

- 

Press the **MENU** key, move the cursor to **123** in the main menu by means of the arrow keys (**▲**, **▼**) and confirm with **ENTER**. Subsequently the instrument displays a screen similar to the one reported here to the side.

- 

Use the arrow keys **▲**, **▼** to set the measuring mode of the instrument, which may be: **1T**, **2T**.
It is not necessary to confirm the selection with ENTER.
- Insert the blue and black connectors of the single cables into the corresponding input leads N and P of the instrument. Apply the relevant alligator clips to the free ends of the cables. It is also possible to use the remote probe by inserting its multipolar connector into the input lead P. Connect the alligator clips, the probes or the remote probe to the electrical mains according to Fig. 24 and Fig. 25.
- 

Press the **GO/STOP** key on the instrument or the **START** key on remote probe. The instrument will start the measurement.

CAUTION



If message **“Measuring...”** appears on the display, the instrument is performing measurement. During this whole stage, do not disconnect the test leads of the instrument from the mains.

5. The instrument switches to stand-by mode and displays the screen reported here to the side until the test lead detects a voltage higher than the minimum limit value

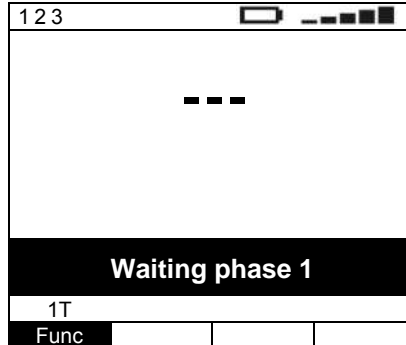

Waiting for phase 1

6. When the instrument detects a voltage higher than the minimum limit value on the test lead, the instrument displays the screen reported here to the side and starts measuring the first voltage. The instrument gives a long acoustic signal until input voltage is present

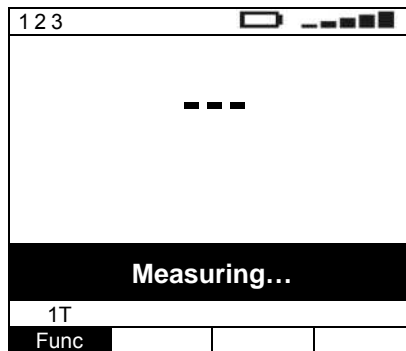

Measuring phase 1

7. Once acquisition is completed, the instrument switches to stand-by mode and displays the screen reported here to the side until the test lead detects again a voltage higher than the minimum limit value

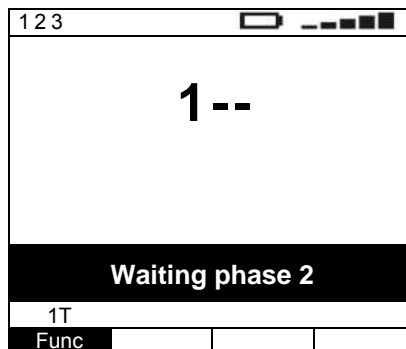

Waiting for phase 2

8. Move the black test lead to the second voltage of the sequence tested as in Fig. 26 and Fig. 27.

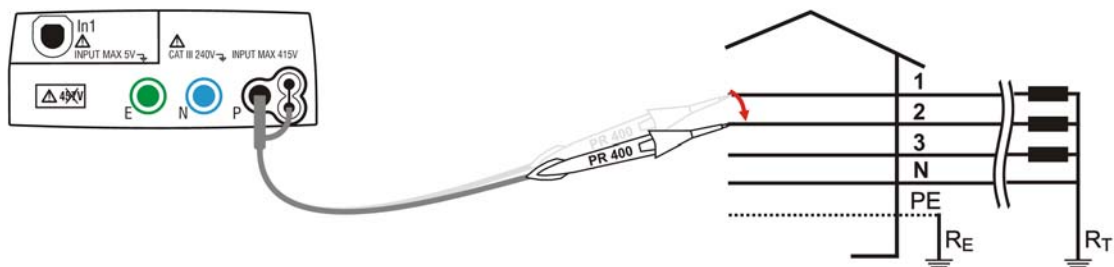

Fig. 26: Instrument connection for measuring the phase sequence with one lead, phase 2 connection

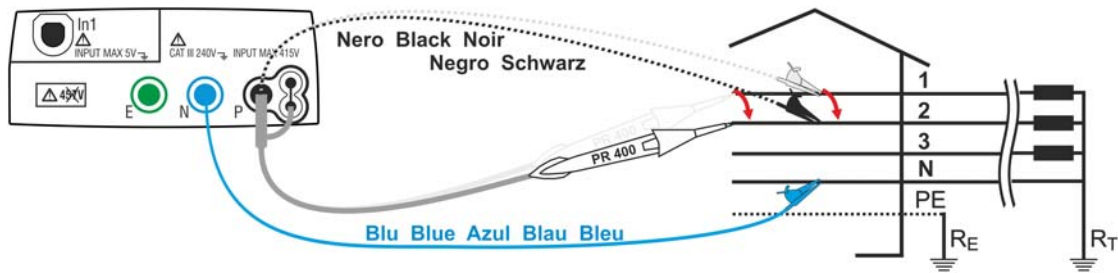
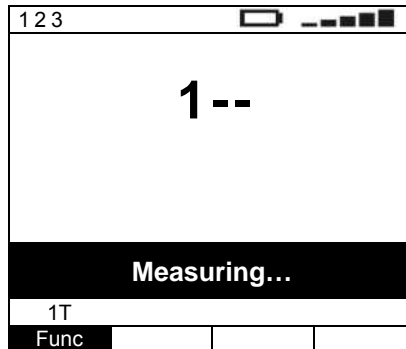

Fig. 27: Instrument connection for measuring the phase sequence with two leads, phase 2 connection

9. When the instrument detects a voltage higher than the minimum limit value on the test lead, the instrument displays the screen reported here to the side and starts measuring the second voltage. The instrument gives a long acoustic signal until input voltage is present



Measuring phase 2

10. Once acquisition is completed, if the instrument has detected a correct phase sequence, it displays 123 and the message OK. It also gives a double acoustic signal

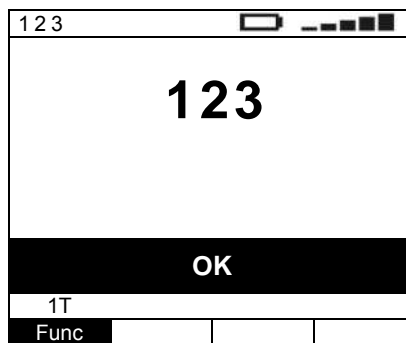

Correct phase sequence

11. Once acquisition is completed, if the instrument has detected two voltages in phase, it displays a screen similar to the one reported here to the side and gives a double acoustic signal

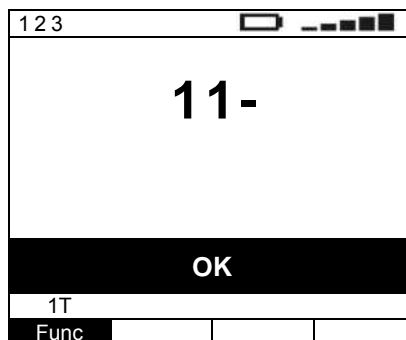

Phase conformity

12.  The results displayed can be saved by pressing the **SAVE** key twice or the **SAVE** key and, subsequently, the **ENTER** key (§ 8.1)

6.7.1. Description of anomalous results

1. Once acquisition is completed, if the instrument has detected an uncorrect phase sequence, it displays a screen similar to the one reported here to the side and gives a long acoustic signal

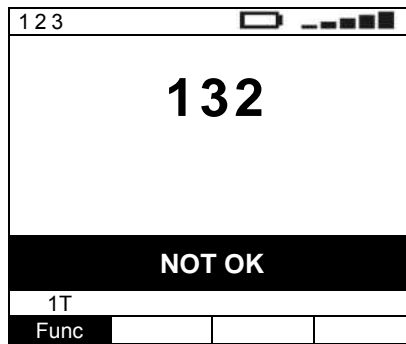

Correct phase sequence

2.  The results displayed can be saved by pressing the **SAVE** key twice or the **SAVE** key and, subsequently, the **ENTER** key (§ 8.1)

3. If between the acquisition of the first and second voltage a time higher than the limit time has elapsed, the instrument displays a screen similar to the one reported here to the side and gives a long acoustic signal

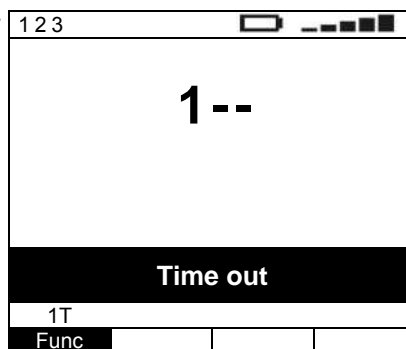

4. If, during voltage acquisition, the instrument detects an input voltage higher than the maximum limit value, it displays a screen similar to the one reported here to the side and stops measuring

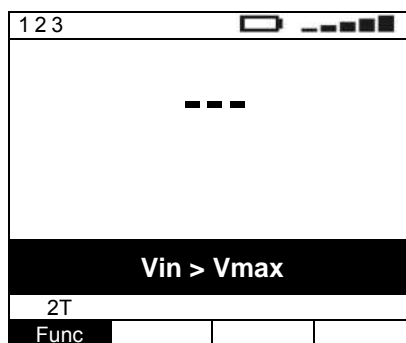

5.  The previous anomalous results cannot be saved

6.8. AUX: REAL TIME MEASUREMENT OF THE ENVIRONMENTAL PARAMETERS

By means of external transducers, this function allows measuring the following environmental parameters:

- **AIR** air speed by means of air-speed transducer
- **RH** air humidity by means of humidity transducer
- **TMP °F** air temperature in °F by means of thermometric transducer
- **TMP °C** air temperature in °C by means of thermometric transducer
- **Lux** lighting by means of luxmetric transducer
- **VOLT** input voltage (without applying any transduction constant)

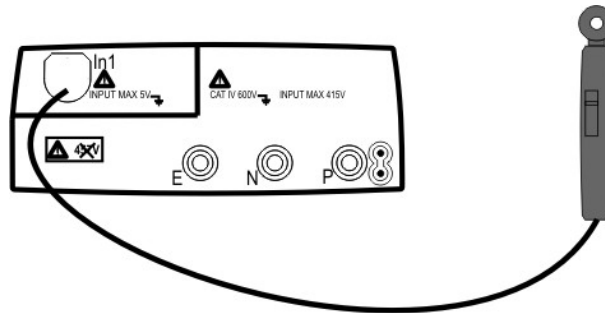



Fig. 28: Connection between an environmental probe and the instrument

1.  Press the **MENU** key, move the cursor to **AUX** in the main menu by means of the arrow keys (**▲**, **▼**) and confirm with **ENTER**. Subsequently the instrument displays a screen similar to the one reported here to the side. The instrument measures and shows on the display the instant value of the input parameter in real time, and **RUN** appears in the right bottom part of the display

AUX			
In1 = 7.08 Lux			
Lux	LX 20	RUN	
Func	FS		

2.  Use the **◀**, **▶** keys to select the parameter to be modified, and the **▲**, **▼** keys to modify the parameter value.
It is not necessary to confirm the selection with ENTER.

Func The virtual Func key allows setting the the type of environmental measurement to perform, which may be: **AIR, RH, TMP °F, TMP °C, Lux, VOLT**

FS The virtual FS key, active only when the Lux mode has been selected with the Func key, allows selecting the clamp full scale among the values: **20, 2k, 20k**

6.8.1. AIR, RH, TMP °F, TMP °C, Lux mode

- Insert the connector of the probe being used into the instrument input In1 making sure that the probe connected and the set measurement unit correspond

-  Press the **GO/STOP** key. The instrument stops updating the measured value and **STOP** appears on the right bottom part of the display. Press the same key again to restart the measurement and the real-time display of the instant value of the input parameter. In this case, **RUN** appears on the right bottom part of the display.

AUX		[Battery Icon]	
In1 = 7.08 Lux			
Lux		LX 20	
Func		STOP	
Func		FS	



-  Measures can be saved, both in RUN and in STOP mode, by pressing the **SAVE** key twice or the **SAVE** key and, subsequently, the **ENTER** key (§ 8.1)

6.8.2. Description of anomalous results

- In AIR, RH, TMP °F, TMP °C, Lux or VOLT mode, if the instrument measures an input value higher than the full scale, it displays a screen similar to the one reported here to the side. Check that the full scale selected on the instrument matches the full scale on the transducer

AUX		[Battery Icon]	
In1 > 20.00 kLux			
Lux		Lx 20k	
Func		FS	
Func		FS	

Measured value higher than the instrument's full scale

-  The results displayed can be saved by pressing the **SAVE** key twice or the **SAVE** key and, subsequently, the **ENTER** key (§ 8.1)
-  The previous anomalous result cannot be saved

6.9. LEAK: REAL TIME MEASUREMENT OF THE LEAKAGE CURRENT THROUGH AN EXTERNAL CLAMP

Using an external clamp, this function allows measuring the leakage current.

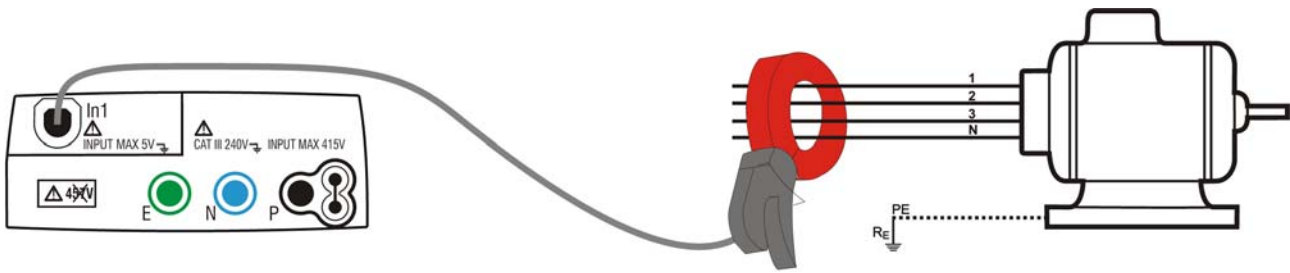

Fig. 29: Indirect measurement of leakage current in three-phase systems

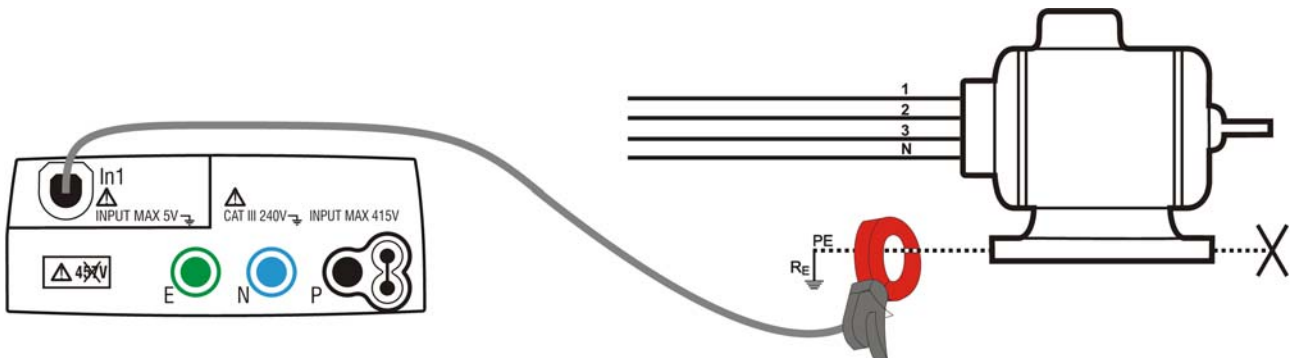





Fig. 30: Direct measurement of leakage current in three-phase systems

1.  Press the **MENU** key, move the cursor to **LEAK** in the main menu by means of the arrow keys (\blacktriangle , \blacktriangledown) and confirm with **ENTER**. Subsequently the instrument measures in real time and displays, in a screen similar to the one reported here to the side, the instant value of the input parameter, and **RUN** appears on the right bottom part of the display

LEAK					
I	=	00.0	A		
I _{max}	=	00.0	A		
100A		RUN			
FS					
2.  Use the arrow keys \blacktriangle , \blacktriangledown to select the clamp full scale among the values: **1A, 10A, 30A, 100A, 200A, 300A, 400A, 1000A, 2000A, 3000A**. the changes made to the FS value will also be applied to the PWR function (§ 7.1). **It is not necessary to confirm the selection with ENTER.**
3. The FS set on the instrument has always to match the one on the clamp being used. For the leakage current, the instrument and the clamp are generally set to FS=1A
4. Insert the clamp connector into the instrument input In1
5. For indirect measurements of the leakage current, connect the external clamp according to Fig. 29. For direct measurements of the leakage current, connect the external clamp according to Fig. 30 and disconnect possible additional earth connections which could influence the test results

CAUTION



Possible additional earth connections could influence the measured value. For the difficulty of this measurement and the sometimes real difficulty in removing the clamps, we recommend performing the measurement indirectly.

6.



Press the **GO/STOP** key. The instrument stops updating the measured value and **STOP** appears on the right bottom part of the display. Press the same key again to restart the measurement and the real-time display of the instant value of the input parameter. In this case, **RUN** appears on the right bottom part of the display

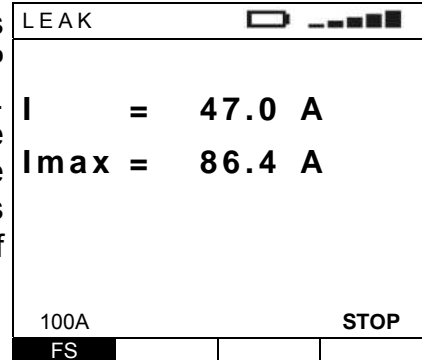

7.



The results displayed can be saved, both in RUN and in STOP mode, by pressing the **SAVE** key twice or the **SAVE** key and, subsequently, the **ENTER** key (§ 8.1)

6.9.1. Description of anomalous results

1. If the instrument detects that the current is higher than the one of the set full scale, the screen on the side will be displayed. Check that the full scale selected on the instrument matches the full scale on the transducer

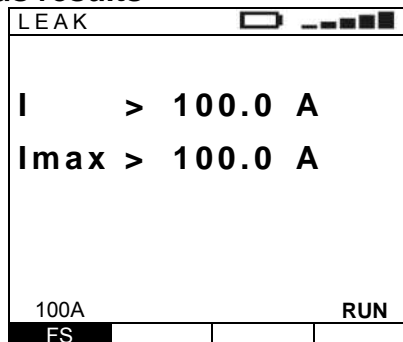

Measured value higher than the instrument's full scale
--

2.



The results displayed can be saved by pressing the **SAVE** key twice or the **SAVE** key and, subsequently, the **ENTER** key (§ 8.1)

7. MAINS ANALYSIS

7.1. PWR: REAL TIME MEASUREMENT OF THE MAINS PARAMETERS

This function allows measuring the voltage of the electrical mains and of the relevant harmonics. Using an external clamp, it is also possible to measure the current and the relevant harmonics as well as other electrical parameters such as power, power factor, etc. The following operating modes are available:

- **PAR** measurement of electrical parameters such as current, voltage, power, power factor, etc.
- **HRM V** measurement of voltage harmonics
- **HRM I** measurement of current harmonics

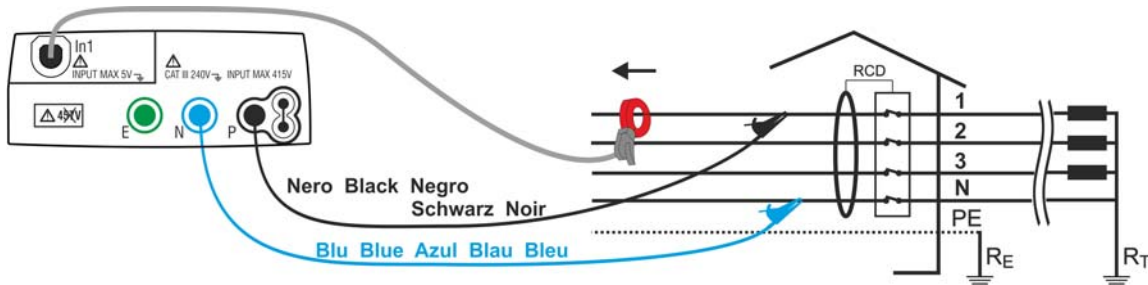



Fig. 31: Instrument connection for single-phase, double-phase or three-phase measurements

- 

Press the **MENU** key, move the cursor to **PWR** in the main menu by means of the arrow keys (**▲**, **▼**) and confirm with **ENTER**. The instrument measures in real time and displays, in a screen similar to the one reported here to the side, the instant value of the input parameters, and **RUN** appears on the right bottom part of the display

PWR			
V	=	230.8 V	
I	=	27.2 A	
f	=	50.0 Hz	
P	=	5.09 kW	
S	=	6.28 kVA	
Q	=	2.14 kVAR	
pf	=	0.94 i	
dpf	=	0.94 i	
PAR	100A	4005	RUN
Func	FS	TYPE	
- 

Use the **◀**, **▶** keys to select the parameter to be modified, and the **▲**, **▼** keys to modify the parameter value.
It is not necessary to confirm the selection with ENTER.

Func The virtual Func key allows setting the measuring mode of the instrument, which may be: **PAR**, **HRM V**, **HRM I**

FS The virtual FS key, active only when the PAR mode has been selected with the Func key, allows selecting the clamp full scale among the values: **1A**, **10A**, **30A**, **100A**, **200A**, **300A**, **400A**, **1000A**, **2000A**, **3000A**. The changes made to the FS value will also be applied to the LEAK function (§ 6.9). If the FS 100A has been set, it's possible to select the clamp model: Type = "4005" (HT4005) or "STD" (Standard clamp).

PAG The virtual FS key, active only when the HRM V or the HRM I mode has been selected with the Func key, allows scrolling down the bar graph of the harmonics window by window. Following options are available: **h02÷h08**, **h09÷h15**, **h16÷h22**, **h23÷h29**, **h30÷h36**, **h37÷h43**, **h44÷h50**

hxx The virtual FS key, active only when the HRM V or the HRM I mode has been selected with the Func key, allows increasing or decreasing the ordinal harmonic number whose value is displayed

3. Insert the clamp connector into the instrument input In1
4. Staple the phase to be tested. Insert both the **black** and **blue** connectors of the single cables into the relative **P** and **N** instrument input leads. Insert the relative alligator clips into the free end of the cables and connect the test leads to the test ends of the conductor to be tested as in Fig. 31. The arrow on the clamp must point in the direction of the power flow, i.e. from generator to load

7.1.1. PAR mode

5.  Press the **GO/STOP** key. The instrument stops updating the measured values and **STOP** appears on the right bottom part of the display. Press the same key again to restart the measurement and the real-time display of the instant values of the input parameters. In this case, **RUN** appears on the right bottom part of the display

PWR			
V	=	230.8	V
I	=	27.2	A
f	=	50.0	Hz
P	=	5.09	kW
Q	=	2.14	kVAR
S	=	6.28	kVA
pf	=	0.94	i
dPf	=	0.94	i
PAR	100A	4005	STOP
Func	FS	TYPE	

6.  The results displayed can be saved, both in RUN and in STOP mode, by pressing the **SAVE** key twice or the **SAVE** key and, subsequently, the **ENTER** key (§ 8.1)

7.1.2. HRM V and HRM I mode

8.  Press the **GO/STOP** key. The instrument stops updating the measured value and **STOP** appears on the right bottom part of the display. Press the same key again to restart the measurement and the real-time display of the instant value of the input parameter. In this case, **RUN** appears on the right bottom part of the display

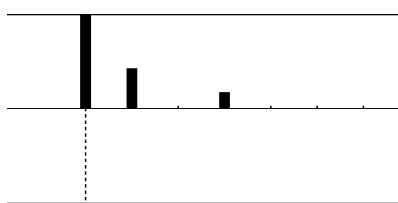
PWR			
			
h02	=	10.0	%
thdV	=	11.5	%
HRM V	↑↓	↑↓	STOP
Func	PAG	hxx	

7.  The results displayed can be saved, both in RUN and in STOP mode, by pressing the **SAVE** key twice or the **SAVE** key and, subsequently, the **ENTER** key (§ 8.1)

8. MEMORY

8.1. HOW TO SAVE A MEASURE

- When the SAVE key is first pressed, as described in the §s regarding the different measurements, the instrument displays a screen similar to the one on the side

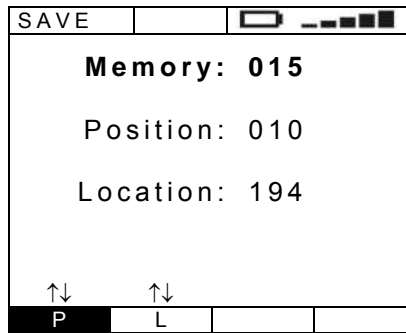

First available memory location (last saved + 1)

Last P parameter set value

Last L parameter set value

- the P (place) and L (location) parameters can be used to facilitate the operator's task in determining the point in which the measurement was carried out. These parameters values can be modified from 001 to 255, and is not bound to the memory location in which the results will be saved and which keeps increasing
- It is not possible to set the memory location in which the measure is saved. The instrument always uses the first location available, i.e. the next location available after the last used one

- Use the ◀, ▶ keys to select the parameter to be modified, and the ▲, ▼ keys to modify the parameter value.

As an alternative:

- or Press the **ENTER** or **SAVE** key to save the measure. The instrument gives a double acoustic signal to confirm the saving

Or:

- Press the **ESC** key to exit without saving

8.1.1. Description of anomalous results

- Should you effect a saving procedure when all 500 memory cells are full, the instrument displays a screen similar to the one reported here to the side

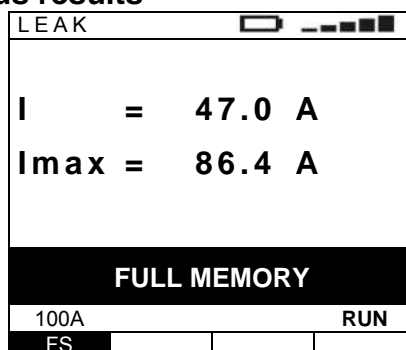

The whole instrument memory has already been used

8.2. SAVED DATA MANAGEMENT

- 

Press the **MENU** key, move the cursor to **MEM** in the main menu by means of the arrow keys (**▲**, **▼**) and confirm with **ENTER**. Subsequently the instrument displays a screen similar to the one reported here to the side where the following are listed:

- **MEM** the occupied memory location
- **TIPO** the kind of measurement performed
- **P** the P parameter value
- **L** the L parameter value

The different performed measurements are displayed in rising cell order (from the oldest to the most recent one). The number of used memory cells and the number of available locations is also displayed

MEM			
MEM	TIPO	P	L
001	LOW Ω	110	096
002	LOW Ω	110	096
003	LOW Ω	110	096
004	LOW Ω	110	096
005	LOW Ω	110	096
006	LOW Ω	110	096
007	LOW Ω	110	096
TOT:392		FREE:108	
↑↓		↑↓ TOT	
REC	PAG	CANC	

- 

Use the **◀**, **▶** keys to select the parameter to be modified, and the **▲**, **▼** keys to modify the parameter value.

REC The virtual REC key scrolls down the measurements displayed one by one thus allowing the selection of the one to be recalled

PAG The virtual PAG key scrolls down the measurement displayed in each page (by groups of 7 measurements) thus allowing a faster selection of the measure to be recalled

CANC The virtual CANC key allows deleting the last or all the measures stored in the memory. Following options are available: **ULT**, **TOT**

8.2.1. How to recall a measure

- 

By means of the REC and PAG virtual keys select the measure to display. Pressing the **ENTER** key the instrument will display the selected measure and its info

RCD			
	0°	180°	
x 1/2	>999ms	>999ms	
x 1	28ms	31ms	
x 5	8ms	10ms	
FRQ=50.0Hz		Ut=1.4V	
VP-N=228V		VP-Pe=228V	
RCD OK			
AUTO	30mA		50V
Func	IdN	RCD	UL

- 

Press the **ESC** key to go back to the saved measures list

- 

Press the **ESC** key to go back to the the main menu

8.2.2. How to delete the last measure or all of them

3.  By means of the CANCEL virtual key select LST or TOT whether you want to delete the last measure or all the measures in the memory. Subsequently, press the **ENTER** key. The instrument asks for a confirmation of the deletion by displaying a screen similar to the one reported here to the side

CLR			
DELETE ALL?			
ENTER confirm ESC cancel			

As an alternative:

4.  Press the **ENTER** key to confirm deletion of the measures. In case all the measures in the instrument are deleted, a screen similar to the one reported here to the side is displayed

MEM			
MEM	TYPE	P	L
001	LOW Ω	110	096
002	LOW Ω	110	096
003	LOW Ω	110	096
004	LOW Ω	110	096
005	LOW Ω	110	096
006	LOW Ω	110	096
007	LOW Ω	110	096
TOT:000		FREE:500	
↑↓	↑↓	TOT	
REC	PAG	CANC	

Or:

4.  Press the **ESC** key to go back to the saved measures list

5.  Press the **ESC** key to go back to the the main menu

8.2.3. Description of anomalous results

1. In case there is no measure saved and the instrument's memory is accessed, a screen similar to the one reported here to the side is displayed. No key is active, except for the ESC key to return to the menu instrument management menu

MEM			
MEM	TIPO	P	L
001	LOW Ω	110	096
002	LOW Ω	110	096
003	LOW Ω	110	096
004	LOW Ω	110	096
005	LOW Ω	110	096
006	LOW Ω	110	096
007	LOW Ω	110	096
TOT:000		FREE:500	
↑↓	↑↓	TOT	
REC	PAG	CANC	

9. CONNECTING THE INSTRUMENT TO THE PC

CAUTION



- The connection between instrument and PC is realized by means of cable C2006.
- In order to transfer the data onto a PC it is necessary to install beforehand both the management software Topview and the drivers of cable C2006 on the PC itself.
- Before connecting, it is necessary to select the port to be used and the correct baud rate (57600 bps) on the PC. To set these parameters, launch the **TopView** software provided and refer to the programme's on-line help.
- The selected port must not be engaged by other devices or applications, e.g. a mouse, a modem, etc. Close any applications running using the Microsoft Windows Task Manager function.
- The optical port emits invisible LED radiations. Do not directly observe with optical instruments. Class 1M LED apparatus according to standard IEC/EN 60825-1.

To transfer data to the PC, follow this procedure:

1. Switch on the instrument by pressing the **ON/OFF** key.
2. Connect the instrument to the PC via the provided optical/USB cable **C2006**.
3. Press the **ESC/MENU** key to open the main menu.
4. Use the arrow keys (**▲**, **▼**) to select "**RS232**" to access data transfer mode and confirm with **ENTER**.

MENU	
AUTO	: Ra, RCD, MΩ
LOWΩ	: continuity
MΩ	: insulation
RCD	: RCD test
LOOP	: impedance
Ra	: earth res.
123	: PH sequence
AUX	: environment
LEAK	: leakage curr.
PWR	: analyzer
SET	: settings
MEM	: memory
▶ RS232	: data transfer

5. The instrument shows the following screen:

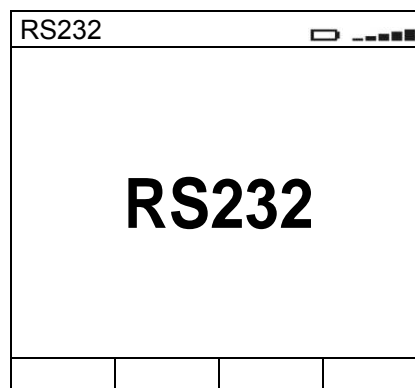

6. Use TopView controls to activate data transfer (please refer to the on-line help of the program).

10. MAINTENANCE

10.1. GENERAL

The instrument you purchased is a precision instrument. When using and storing it, please observe the recommendations listed in this manual in order to prevent any possible damage or danger. Do not use the instrument in environments with high humidity levels or high temperatures. Do not directly expose it to sunlight. Always switch off the instrument after using it. Should the instrument remain unused for a long time, remove batteries in order to prevent liquids from leaking out of them, and the instrument internal circuits from being damaged

10.2. BATTERY REPLACEMENT

When the low battery symbol appears on the LCD display (§ 11.3) it is necessary to replace the batteries.



CAUTION

This operation must be carried out by skilled technicians only. Before carrying out this operation, make sure that all cables have been removed from the input leads.

1. Switch off the instrument by pressing and holding the ON key
2. Remove the cables from the input leads
3. Unscrew the cover fastening screw from the battery compartment and remove it
4. Remove all the batteries from the battery compartment and replace with new batteries of the same type only (§ 11.3) making sure to respect the indicated polarities
5. Restore the battery compartment cover into place and fasten it by mean of the relevant screw
6. Do not disperse the used batteries into the environment. Use relevant containers for disposal

10.3. INSTRUMENT CLEANING

Use a dry and soft cloth to clean the instrument. Never use wet cloths, solvents, water, etc.

10.4. END OF LIFE



CAUTION: this symbol indicates that the equipment and its accessories must be collected separately and disposed of in the right way.

11. SPECIFICATIONS

Accuracy indicated as: $\pm[\%rdg + (\text{num. dgt} * \text{resolution})]$ at 23°C, <80%RH. Refer to the Table 1 for the correspondence between models and available functions

11.1. TECHNICAL FEATURES

Continuity test (LOW Ω)

Range [Ω]	Resolution [Ω]	Accuracy
0.00 ÷ 9.99	0.01	$\pm(2.0\%rdg + 2dgt)$
10.0 ÷ 99.9	0.1	

Test current: >200mA DC up to 5 Ω (include the resistance of the calibration) also with half-charged battery
 Generated current: resolution 1mA, accuracy $\pm(5.0\%rdg + 5dgt)$
 Open circuit test voltage: $4 < V_0 < 24V$
 Function mode: AUTO, R+, R-

Insulation resistance (M Ω)

Test voltage [V]	Range [Ω]	Resolution [Ω]	Accuracy
50	0.01 ÷ 9.99	0.01	$\pm(2.0\%rdg + 2dgt)$
	10.0 ÷ 49.9	0.1	
	50.0 ÷ 99.9	0.1	$\pm(5.0\%rdg + 2dgt)$
100	0.01 ÷ 9.99	0.01	$\pm(2.0\%rdg + 2dgt)$
	10.0 ÷ 99.9	0.1	
	100 ÷ 199	1	$\pm(5.0\%rdg + 2dgt)$
250	0.01 ÷ 9.99	0.01	$\pm(2.0\%rdg + 2dgt)$
	10.0 ÷ 99.9	0.1	
	100 ÷ 249	1	$\pm(5.0\%rdg + 2dgt)$
250 ÷ 499	1		
500	0.01 ÷ 9.99	0.01	$\pm(2.0\%rdg + 2dgt)$
	10.0 ÷ 99.9	0.1	
	100 ÷ 499	1	$\pm(5.0\%rdg + 2dgt)$
	500 ÷ 999	1	
1000	0.01 ÷ 9.99	0.01	$\pm(2.0\%rdg + 2dgt)$
	10.0 ÷ 99.9	0.1	
	100 ÷ 999	1	$\pm(5.0\%rdg + 2dgt)$
	1000 ÷ 1999	1	

Open circuit test voltage: < 1.25 x nominal test voltage
 Short circuit current: < 15mA (peak) with each test voltage
 Generated voltage: resolution: 1V, Accuracy $\pm(5.0\%rdg + 5dgt)$ @ $R_{mis} > 0.5\% FS$
 Nominal test current: > 2.2mA with 230k Ω @ 500V ; >1mA with 1k Ω @ other V_{nom}

Test on RCDs

Phase-neutral and phase-earth voltage range (110 ÷ 240V) $\pm 10\%$
 Frequency 50Hz $\pm 0.5Hz$, 60Hz $\pm 0.5Hz$
 Nominal test current (IdN) 10mA, 30mA, 100mA, 300mA, 500mA, 650mA, 1A
 Contact voltage (ULIM) 25V, 50V

Tripping time (x $\frac{1}{2}$, x1, x2, x5, AUTO)

Multiplier [x IdN]	Range [ms]	Resolution [ms]	Accuracy
$\frac{1}{2}$, 1	1 ÷ 999 general and selective	1	$\pm(2.0\%rdg + 2dgt)$
2	1 ÷ 200 general		
	1 ÷ 250 selective		
5	1 ÷ 50 general		
	1 ÷ 160 selective		

RCD type: AC () , A () , general and selective
 multiplier x1, x2, x5, AUTO: accuracy: -0%, +10% IdN
 multiplier x $\frac{1}{2}$: accuracy: -10%, +0% IdN

Tripping current (I_n)

IdN [mA]	Type	Range IdN [mA]	Resolution [mA]	Accuracy
≤ 10	AC	(0.5 ÷ 1.1) IdN	0.1IdN	-0%, +10%rdg
	A	(0.3 ÷ 1.1) IdN		
> 10	AC	(0.5 ÷ 1.1) IdN		
	A	(0.3 ÷ 1.1) IdN		

RCD type: AC (⌚), A (⌚), general and selective
 Tripping time resolution 1ms, Accuracy ±(2.0%rdg + 2dgt)

Global earth resistance without RCD's tripping (Ra)

Range [Ω]	Resolution [Ω]	Accuracy
1 ÷ 1999	1	±(5.0%rdg + 3dgt)

RCD type: AC (⌚), A (⌚), general and selective
 Test current < ½ IdN, accuracy: -10%, +0% IdN
 Contact voltage Ut range: 0 ÷ 2Ut lim, resolution: 0.1V, accuracy: -0%, +(5%rdg + 3dgt)

Line/Loop fault impedance

Phase-neutral and phase-earth voltage range (110 ÷ 240V) ±10%
 Phase-phase voltage range (110 ÷ 415V) ±10%
 Frequency 50Hz ±0.5Hz, 60Hz ±0.5Hz

TT and TN systems

Range [Ω]	Resolution [Ω]	Accuracy
0.01 ÷ 19.99	0.01	±(5.0%rdg + 3dgt)
20.0 ÷ 199.9	0.1	
200 ÷ 1999 (phase-earth only)	1	

Max peak test current at test voltage 3A @ 127V, 6A @ 230V, 10A @ 400V

IT systems (first fault current)

Range [mA]	Resolution [mA]	Accuracy
5 ÷ 999	1	±(5.0%rdg + 3dgt)

Contact voltage (ULIM) 25V, 50V

Global earth resistance (Ra)

Range [Ω]	Resolution [Ω]	Accuracy
0.01 ÷ 19.99	0.01	±(5.0%rdg + 1Ω)
20.0 ÷ 199.9	0.1	
200 ÷ 1999 (phase-earth only)	1	

Test current: <15mA
 Contact voltage (ULIM): 25V, 50V
 Phase-neutral and phase-earth: (110 ÷ 240V) ±10%
 Frequency: 50Hz ±0.5Hz, 60Hz ±0.5Hz

Phas sequence (123)

Phase-neutral and phase-earth voltage range (110 ÷ 240V) ±10%
 Frequency 50Hz ±0.5Hz, 60Hz ±0.5Hz

Leakage current (LEAK)

Range [mV]	Resolution [mV]	Accuracy
1 ÷ 1200.0	0.1	±(1.0%rdg + 2dgt)

Max crest factor: ≤ 3
 Response time: 10ms
 Frequency: 50Hz ±0.5Hz, 60Hz ±0.5Hz

Environmental parameters (AUX)

Parameter	Range	Resolution	Transduced signal	Accuracy
Temperature	-20.0 ÷ 80.0°C	0.1°C	-20 ÷ +80mV	±(2.0%rdg + 2dgt)
	-4.0 ÷ 176.0°F	0.1°F	-4 ÷ +176mV	
Humidity	0.0 ÷ 100.0% RH	0.1% RH	0 ÷ +100mV	
DC voltage	±(0.0 ÷ 999.9mV)	0.1mV	±(0.2 ÷ 999.9mV)	
Luminance	0.001 ÷ 20.00Lux	0.001 ÷ 0.02Lux	0 ÷ +100mV	
	0.1 ÷ 2000Lux	0.1 ÷ 2Lux	0 ÷ +100mV	
	1 ÷ 20000Lux	0.1 ÷ 2Lux	0 ÷ +100mV	

Mains analysis (PWR)
Frequency measurement

Range [Hz]	Resolution [Hz]	Accuracy
47.0 ÷ 63.0	0.1	±(2.0%rdg + 2dgt)

Voltage range: 5.0 ÷ 265.0
 Current range: 0.005 ÷ 1.2 x FS

Voltage measurement

Range [V]	Resolution [V]	Accuracy
5.0 ÷ 265.0	0.1V	±(0.5%rdg + 2dgt)

Max crest factor: ≤ 1,5
 Frequency: 47.0 ÷ 63.0 Hz

Voltage harmonics measurement

Range [V]	Resolution [V]	Order	Accuracy
0.0 ÷ 265.0	0.1V	2 ÷ 15	±(2.0%rdg + 5dgt)
		16 ÷ 49	±(5.0%rdg + 10dgt)

Frequency fundamental 47.0 ÷ 63.0 Hz

Current measurement

Range [A]	Resolution [A]	Accuracy
0.005 ÷ 1.2 x FS	See Table 2	±(1.0%rdg + 2dgt)

Max crest factor: ≤ 3
 Frequency: 47.0 ÷ 63.0 Hz

Current harmonics measurement

Range [V]	Resolution [A]	Order	Accuracy
0.005 ÷ 1.2 x FS	See Table 2	2 ÷ 15	±(2.0%rdg + 5dgt)
		16 ÷ 49	±(5.0%rdg + 10dgt)

Frequency fundamental 47.0 ÷ 63.0 Hz
 Current fundamental ≥ 0.020 x FS

Full scale [A]	Resolution [A]	Full scale [A]	Resolution [A]
1	0.001	300	0.1
10	0.01	400	0.1
30	0.01	1000	1
100	0.1	2000	1
200	0.1	3000	1

Table 2: Clamp and instrument full scale and resolution values

Measurement of the active, reactive and apparent power @ $V_{mis} > 60V$, $\cos\phi = 1$, $f = 50.0Hz$

Range [W, VAR, VA]	Resolution [W, VAR, VA]	Clamp full scale [A]	Accuracy
0.0 ÷ 999.9	0.1	FS ≤ 1	±(1.0%rdg + 6dgt)
1.000 ÷ 9.999 k	0.001 k		
0.000 ÷ 9.999 k	0.001 k	1 < FS ≤ 10	
10.00 ÷ 99.99 k	0.01 k		
0.00 ÷ 99.99 k	0.01 k	10 < FS ≤ 100	
100.0 ÷ 999.9 k	0.1 k		
0.0 ÷ 999.9 k	0.1 k	100 < FS ≤ 3000	
1000 ÷ 9999 k	1 k		

Measurement of the power factor ($\cos\phi$) @ $V_{mis} > 60V$, $f = 50.0Hz$

Current range [A]	Range	Resolution	Accuracy
0.005 ÷ 0.1 x FS	0.80c ÷ 1.00 ÷ 0.80i	0.01	± 2°
0.1 ÷ 1.2 x FS			± 1°

11.2. REFERENCE GUIDELINES

11.2.1. General

Instrument safety:	IEC/EN61010-1, IEC / EN61557-1, -2, -3, -4, -6, -7
Technical documentations:	IEC/EN61187
Accessory safety:	IEC/EN61010-031, IEC/EN61010-2-032
Insulation:	double insulation
Pollution level:	2
Max height of use:	2000m (6562ft)
Overvoltage category:	CAT III 240V to earth, max 415V among inputs P, N, PE 5V to ground, max 7.2V _{peak to peak} between pins of In1 Input

11.2.2. Reference standards for verification measurements

LOW Ω (200mA):	IEC/EN61557-4
M Ω :	IEC/EN61557-2
RCD:	IEC/EN61557-6
LOOP P-P, P-N, P-PE:	IEC/EN61557-3
Ra 15 _{mA}	IEC/EN61557-3
123:	IEC61557-7

11.3. GENERAL CHARACTERISTICS

Mechanical data

Dimensions (L x W x H):	235 x 165 x 75mm (9 x 6 x 3in)
Weight (batteries included):	1250g (44ounces)

Power supply

Battery type:	6 batteries 1.5 V – LR6 – AA – AM3 – MN 1500
Low battery indication:	the symbol  is displayed when the battery voltage is too low
Battery life:	approx >600 tests in all safety tests approx 48 hours in PWR function
Auto power off:	if set to ON after about 5 minutes from the last key press or measurement the instrument turns off automatically

Miscellaneous

Display:	LCD custom with backlight 73x65 mm
Memory:	500 memory locations
PC interface:	optical port

11.4. ENVIRONMENT

11.4.1. Environmental working conditions

Reference temperature:	23° ± 5°C (73°F ± 41°F)
Working temperature:	0 ÷ 40°C (32°F ÷ 104°F)
Relative humidity allowed:	<80%HR
Storage temperature:	-10 ÷ 60°C (14°F ÷ 140°F)
Storage humidity:	<80%HR

This instrument satisfies the requirements of Low Voltage Directive 2006/95/EC (LVD) and of EMC Directive 2004/108/EC

11.5. ACCESSORIES

See packing list.

12. SERVICE

12.1. WARRANTY CONDITIONS

This instrument is guaranteed against any defect in material and manufacturing in compliance with the general sales terms and conditions. Throughout the period of guarantee all defective parts may be replaced and the manufacturer reserves the right to repair or replace the product.

If the instrument is to be returned to the after-sales service or to a dealer transportation costs are on the customer's behalf. Shipment shall be however agreed upon. A report must always be enclosed to a rejected product stating the reasons of its return. To ship the instrument use only the original packaging material; any damage that may be due to non-original packing shall be charged to the customer. The manufacturer declines any responsibility for damages caused to persons and/or objects.

Warranty is not applied in the following cases:

- Repair and/or replacement of accessories and battery (not covered by warranty)
- Any repair that might be necessary as a consequence of a misuse of the instrument or of its use with no compatible devices.
- Any repair that might be necessary as a consequence of improper packaging.
- Any repair that might be necessary as a consequence of service actions carried out by unauthorized personnel.
- Any modification of the instrument carried out without the authorization of the manufacturer.
- Use not provided for in the instrument's specifications or in the instruction manual.

The contents of this manual may not be reproduced in any form whatsoever without the manufacturer's authorization.

All our products are patented and their trademarks registered. The manufacturer reserves the right to modify the product specifications and prices if this is aimed at technological improvements.

12.2. SERVICE

If the instrument does not operate properly, before contacting the after-sales service check cables as well as test leads and replace them if necessary. Should the instrument still operate improperly check that the operation procedure is correct and conforms with the instructions given in this manual.

If the instrument is to be returned to the after-sales service or to a dealer transportation costs are on the customer's behalf. Shipment shall be however agreed upon. A report must always be enclosed to a rejected product stating the reasons of its return. To ship the instrument use only the original packaging material; any damage that may be due to non-original packing shall be charged to the customer.

13. PRACTICAL REPORTS FOR ELECTRICAL TESTS

13.1. CONTINUITY MEASUREMENT ON PROTECTIVE CONDUCTORS

13.1.1. Purpose of the test

Check the continuity of:

- Protective conductors (PE), main equalizing potential conductors (EQP), secondary equalizing potential conductors (EQS) in TT and TN-S systems
- Neutral conductors having functions of protective conductors (PEN) in TN-C system.

This test is to be preceded by a visual check verifying the existence of yellow-green protective and equalizing potential conductors as well as compliance of the \S s used with the standards' requirements.

13.1.2. Installation parts to be checked

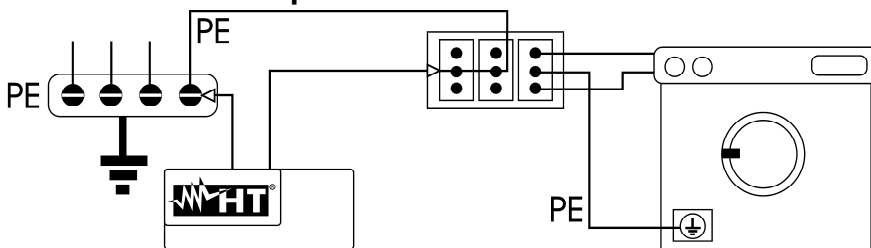

Connect one of the test lead to the protective conductor of the socket and the other to the equalising potential node of the earth installation.

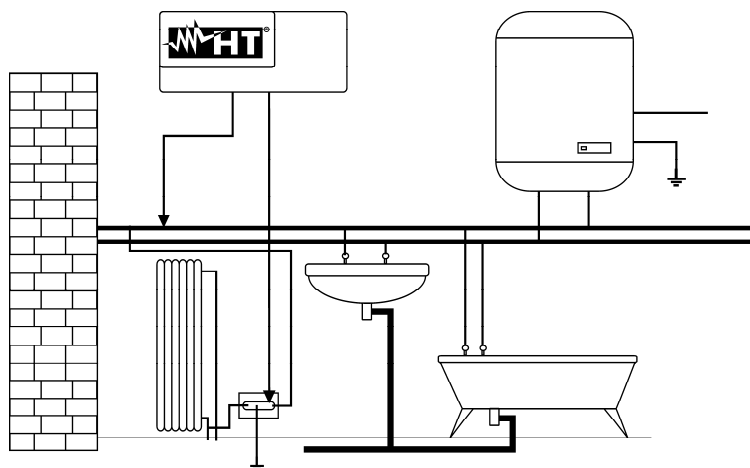

Connect one of the test lead to the external mass (in this case the water pipe) and the other to the earth installation using for example the protective conductor of the closest socket.

Fig. 32: Examples for continuity measurement on conductors

Check the continuity among:

- earth poles of all the plugs and earth collector or node
- earth terminals of class I instruments (boiler etc.) and earth collector or node
- main external masses (water, gas pipes etc.) and earth collector or node
- auxiliary external masses to the earth terminal.

13.1.3. Allowable values

The standards do not give any indication on the maximum resistance values which cannot be overcome, in order to be able to declare the positive outcome of the continuity test. The standards simply require that the instrument in use warns the operator if the test was not carried out with a current of at least 0,2A and an open circuit voltage ranging from 4 to 24V. The resistance values can be calculated according to the \S s and lengths of the conductors under test, anyway if the instrument detects values of some ohm the test can be considered as passed.

13.2. INSULATION RESISTANCE MEASUREMENT

13.2.1. Purpose of the test

Check that the insulation resistance of the installation complies with the requirements of IEE 16th edition standard.

EXAMPLE OF INSULATION MEASUREMENT ON AN INSTALLATION

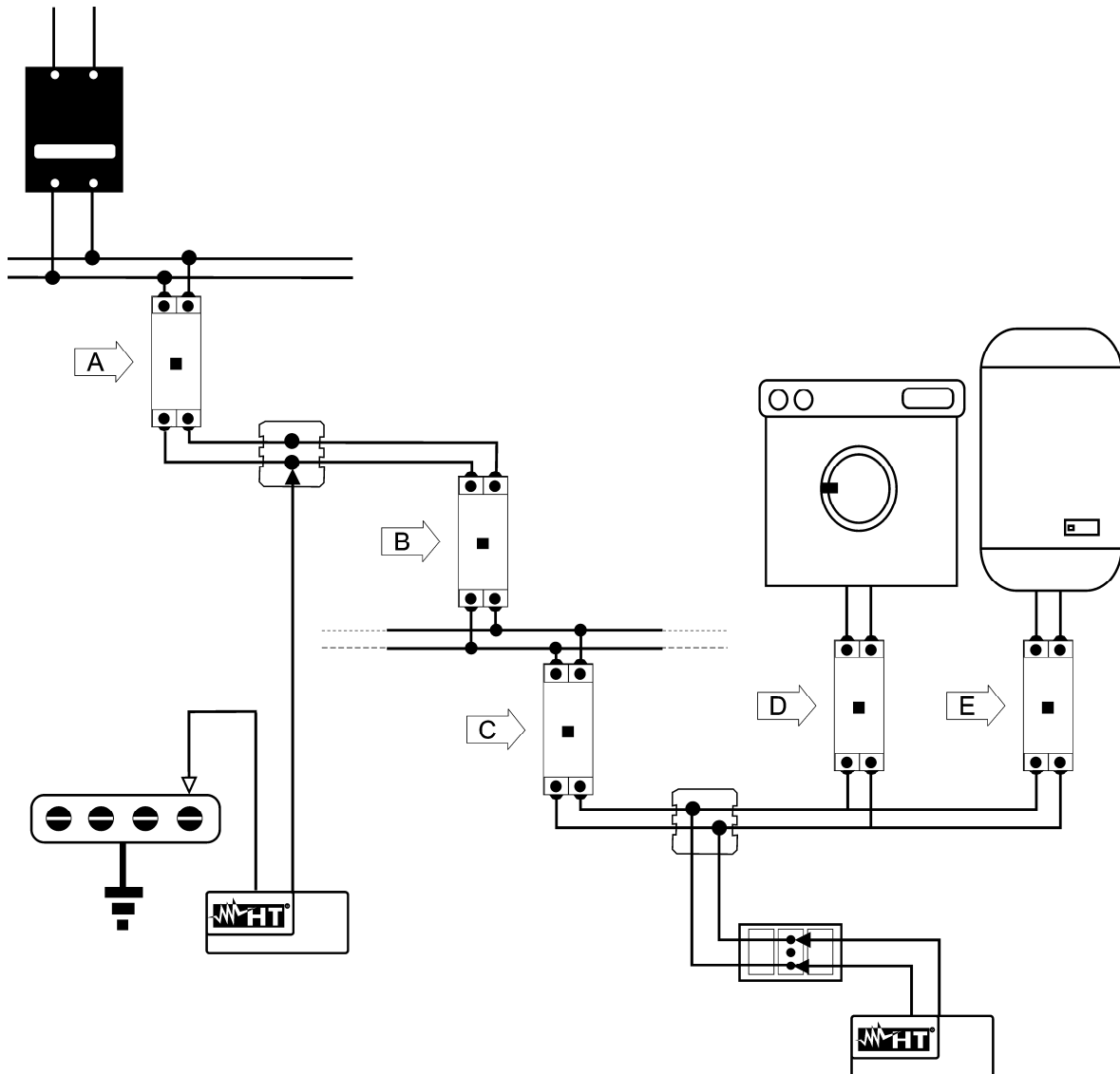

Fig. 33: Insulation measurements on an installation

The switches D and E are those installed near the load having the purpose of separating it from the installation. In case the above said RCDs do not exist, or they are monophasic, it is necessary to disconnect the users from the installation before effecting the insulation resistance test.

A procedure indicating how to effect the insulation resistance measurement on an installation is reported in Table 3

Switch situation		Point under test	Measurement	Judgment on the installation
1.	Turn the switch A, D and E off	Effect the measurement on switch A	If $R \geq R_{LIMIT}$	☺ OK (end of the test)
			If $R < R_{LIMIT}$	Proceed ↗ 2
2.	Turn the switch B off	Effect the measurement on switch A	If $R \geq R_{LIMIT}$	Proceed ↗ 3
			If $R < R_{LIMIT}$	⊗ The insulation level between A and B switches is too low, restore it and effect the measurement another time
3.		Effect the measurement on switch B	If $R \geq R_{LIMIT}$	☺ OK (end of the test)
			If $R < R_{LIMIT}$	⊗ The insulation level after B switch is too low Proceed ↗ 4
4.	Turn the switch C off	Effect the measurement on switch B	If $R \geq R_{LIMIT}$	Proceed ↗ 5
			If $R < R_{LIMIT}$	⊗ The insulation level between B and C switches is too low, restore it and effect the measurement another time
5.		Effect the measurement on switch C	If $R \geq R_{LIMIT}$	☺ OK (end of the test)
			If $R < R_{LIMIT}$	⊗ The insulation level after B switch is too low, restore it and effect the measurement another time

Table 3: Procedure for insulation measurement referred to the installation reported in Fig. 33

If the circuit is quite large the conductors running side by side make up a capacity which is to be charged by the instrument in order to carry out a correct measurement; in this case it is recommended to keep the measurement key pressed (in case a test is effected under manual mode) until the result gets stable.

When effecting measurements among active conductors it is essential to disconnect all the users (alarm lamps, intercom transformers, boilers etc) otherwise the instrument will measure their resistance instead of the installation insulation. Moreover any insulation resistance test among active conductors could damage them.

The indication "**> full scale**" warns that the insulation resistance measured by the instrument is higher than the maximum resistance limit, this result is obviously far higher than the minimum limits of the above table therefore if during a test this symbol is displayed the insulation of that point is to be considered in compliance with standards.

ALLOWABLE VALUES

Rated circuit voltage (V)	Test voltage (V)	Insulation resistance (MΩ)
SELV and PELV*	250	≥0.250
Up to 500 V included, except for the above circuits.	500	≥1.000
Over 500 V	1000	≥1.000

* In the new standards the terms SELV and PELV replace the old definitions "safety low voltage" or "functional".

Table 4: Test voltage values and relative limit values

NOTE:

- ☞ If the circuit is quite large the conductors running side by side make up a capacity which is to be charged by the instrument in order to carry out a correct measurement; in this case it is recommended to keep the **GO** key pressed (in case a test is effected under manual mode) until the result gets stable.
- ☞ The indication "> 1999MΩ" or "o.r." (out of range) warns that the insulation resistance measured by the instrument is higher than the maximum resistance limit (see technical specifications); this result is obviously far higher than the minimum limits of the above table therefore if during a test this symbol is displayed the insulation of that point is to be considered in compliance with standards.

CAUTION

When you effect measurements among active conductors it is essential to disconnect all the users (alarm lamps, intercom transformers, boilers etc) otherwise the instrument will measure their resistance instead of the installation insulation. Moreover any insulation resistance test among active conductors could damage them.

13.3. CHECK OF THE CIRCUIT SEPARATION

13.3.1. Definitions

A **SELV** system is a system of category zero or very low safety voltage featured by: autonomous source (ex. batteries, small generator) or safety (ex. safety transformer) power supply, protection separation to other electrical systems (double or reinforced insulation or a metal screen connected to the earth) and no earthed points (insulated from the earth).

A **PELV** system is a system of category zero or very low safety voltage featured by: autonomous source (ex. batteries, small generator) or safety (ex. safety transformer) power supply, protection separation to other electrical systems (double or reinforced insulation or a metal screen connected to the earth) and there are earthed points (not insulated from the earth).

A system with **electrical separation** is featured by: insulation transformer or autonomous source with equivalent features (ex. generator) power supply, protection separation to other electrical systems (insulation not lower than that of the insulation transformer) and protection separation to the earth (insulation not lower than that of the insulation).

13.3.2. Purpose of the test

The test, to be effected in case the protection is realized through separation (64-8/6 612.4, SELV or PELV or electrical separation), shall check that the insulation resistance measured according to the indications below (depending on the separation type) complies with the limits reported in the table relative to the insulation measurements.

13.3.3. Installation parts to be checked

- **SELV** system (Safety Extra Low Voltage):
 - ✓ measure the resistance between the active parts of the circuit under test (separate) and the active parts of the other circuits
 - ✓ measure the resistance between the active parts of the circuit under test (separate) and the earth.
- **PELV** system (Protective Extra Low Voltage):
 - ✓ measure the resistance between the active parts of the circuit under test (separate) and the active parts of the other circuits.
- **Electrical separation:**
 - ✓ measure the resistance between the active parts of the circuit under test (separate) and the active parts of the other circuits
 - ✓ measure the resistance between the active parts of the circuit under test (separate) and the earth.

13.3.4. Allowable values

The test result is positive when the insulation resistance indicates values higher or equal to those indicated in Table 4

EXAMPLE OF CHECKING THE SEPARATION AMONG ELECTRICAL CIRCUITS

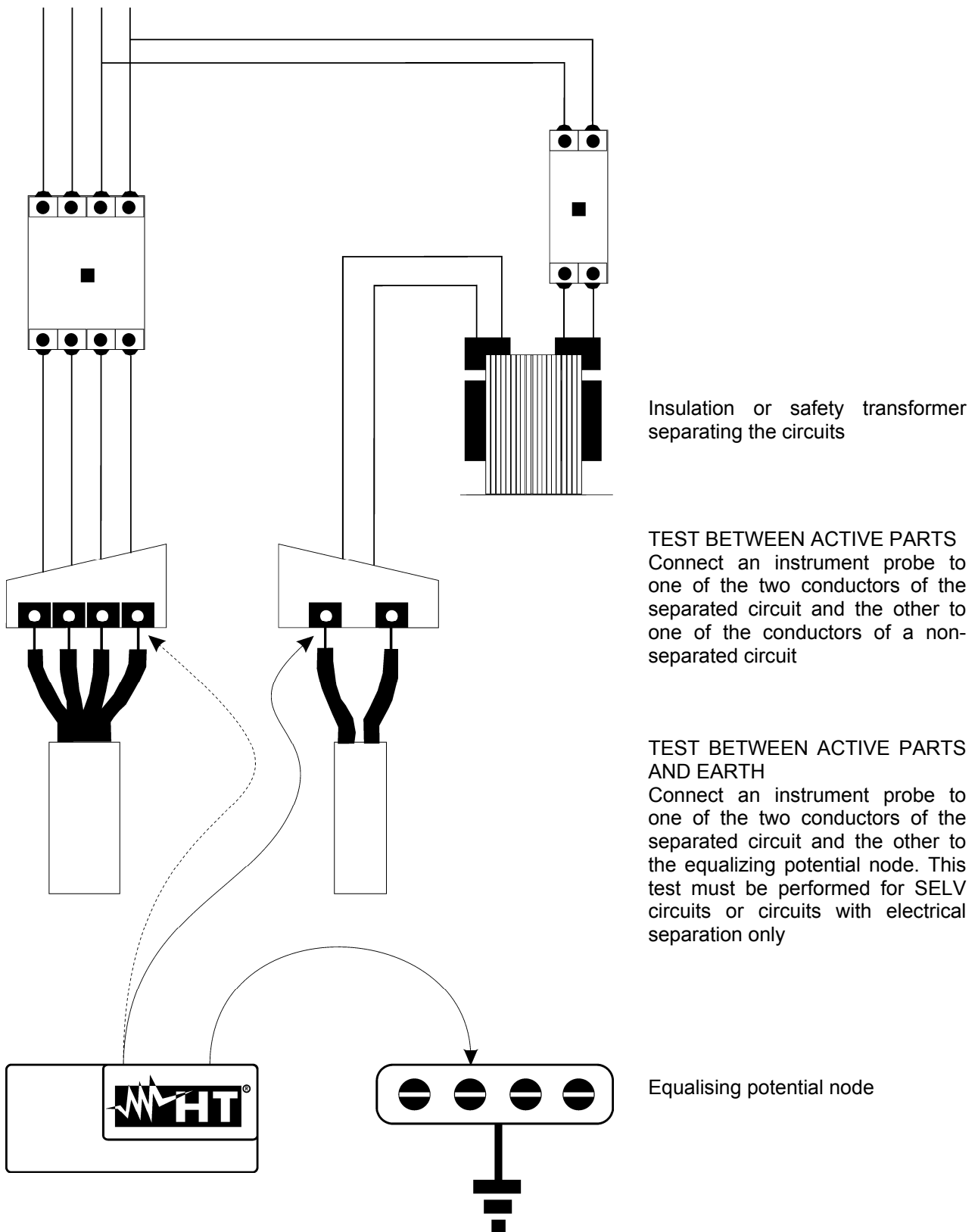

Fig. 34: Measurement of separation among the installation circuits

13.4. WORKING TEST OF RCDS

13.4.1. Purpose of the test

Check whether general and selective RCDs have been installed and adjusted properly and whether they maintain their features over the time. The check shall confirm that the RCD trips at a current I_{dN} lower than its rated working current I_{dN} and that the tripping time meets, depending on the case, the following conditions:

- Does not exceed the maximum time provided by the standards in case of general type RCDs (according to Tab. 5).
- Is included between the minimum tripping time and the maximum one in case of selective type RCDs (according to Tab. 5).

The RCD test effected by means of the test key is aimed at preventing “the gluing effect” from compromising the working of the RCD which has been inactive for a long time; therefore this test is effected only to verify the mechanical working of the RCD and it does not permit to declare that the RCD is complying with the standards. According to a statistical survey the periodical check, once a month, of the RCDs by means of the test key reduces by one half the RCD fault rate, this test however detects only 24% of defective RCDs.

13.4.2. Installation parts to be checked

All the RCDs shall be tested when installed. In the low voltage installations the test is recommended to grant an acceptable safety level. For the medical rooms this check shall be effected periodically every six months on all RCDs.

13.4.3. Allowable values

To compare the measurements make reference to the table reporting the limits for the tripping times. On each RCD it is necessary to effect: a test with leakage current in phase with voltage and a leakage current phase shifted by 180° with respect to the voltage. The highest time is to be considered as significant result. The test at $\frac{1}{2}I_{dN}$ shall never cause the RCD tripping.

RCD type	$I_{dN} \times 1$	$I_{dN} \times 2$	$I_{dN} \times 5^*$	Description
General	0,3s	0,15s	0,04s	Max tripping time in seconds
Selective S	0,13s	0,05s	0,05s	Min tripping time in seconds
	0,5s	0,20s	0,15s	Max tripping time in seconds

* For nominal values $I_{dN} \leq 30\text{mA}$, the test current for 5 times is 0.25A

Table 5: Tripping times for general and selective RCDs

13.4.4. Note

In case the earth installation is not available effect the test connecting the instrument with one terminal on a conductor downstream the RCD and one terminal on the other conductor upstream the RCD itself.

Before effecting the test at the RCD rated current the instrument carries out a test at $\frac{1}{2}I_{dN}$ to measure the contact voltage and the overall earth resistance; if during this test the RCD trips an error message is displayed. During this test the RCD may trip for three possible reasons:

- the RCD tripping current is lower than $\frac{1}{2}I_{dN}$
- an earth plate is already present on the installation which added to the earth generated by the instrument causes the RCD tripping.

If during measurement of contact voltage the voltage detected is higher than the safety value (50V or 25V) the test is interrupted; proceeding with the test under such conditions would mean to keep the contact voltage applied to all the metal masses connected to the earth for a too long time resulting to be dangerous.

Among the test results of the RCD tripping time also the earth resistance value R_a is displayed in Ω , this value for the TN and IT systems is not to be considered while for the TT systems it is merely indicative.

13.5. TEST OF RCD TRIPPING CURRENT

13.5.1. Purpose of the test

Check the real tripping current of the general RCDs (it does not apply to the selective RCDs).

13.5.2. Installation parts to be checked

When facing RCDs with tripping current to be selected it is useful to effect this test to check the real RCD tripping current. For RCDs with fixed differential current this test can be effected to detect any leakage of the installation users. In case the earth installation is not available effect the test connecting one instrument's terminal on a conductor downstream the RCD and one terminal on the other conductor upstream the RCD itself.

13.5.3. Allowable values

The tripping current shall range from $\frac{1}{2}I_{dN}$ to I_{dN} .

13.5.4. Note

Make reference to the notes of the § 13.4.4 too. To check whether significant leakage currents are present on the installation operate as follows:

- After deactivating all the loads effect the tripping current measurement and take note of the value
- Activate the loads and effect a new measurement of the tripping current; if the RCD trips with a lower current, the installation leakage is the difference between the two tripping currents. If during the test the error message is displayed the installation leakage current added to the current for contact voltage measurement ($\frac{1}{2}I_{dN}$) causes the RCD tripping.

This test is not usually performed to compare the tripping time of the switch with the limits prescribed by the standards. In this mode, the instrument detects the exact current and the differential switch's tripping time with the tripping current. Instead, the standards refer to maximum tripping times in case the differential switch is tested with a leakage current equal to the nominal current.

13.6. MEASUREMENT OF SHORT-CIRCUIT IMPEDANCE

13.6.1. Purpose of the test

Check that the tripping power of the protection device is higher than the maximum fault current of the installation.

13.6.2. Installation parts to be checked

The test shall be effected in the point where the short circuit current is the highest possible, usually immediately downstream the RCD to be checked. The test shall be effected between phase and phase (Z_{pp}) in the three phase installations and between phase and neutral (Z_{pn}) in the single-phase installations.

13.6.3. Allowable values

$$\text{Three-phase installations: } P_i > \frac{400}{Z_{pp}} * \frac{2}{\sqrt{3}} \quad \text{Single-phase installations: } P_i > \frac{230}{Z_{pn}}$$

where: P_i = tripping power of the protection device

Z_{pp} = impedance measured between phase and phase

Z_{pn} = impedance measured between phase and neutral

13.7. FAULT LOOP IMPEDANCE MEASUREMENT

13.7.1. Purpose of the test

The fault loop is the circuit of the current when there is a bad isolation of the electrical system toward earth. The fault loop is composed:

- transformer coil impedance
- the impedance of the line from the transformer to the fault
- the impedance of the protective conductor from the conductive part to the neutral of the transformer.

When the instrument measures fault loop impedance, it detects the prospective fault current. So the operator can determinate if magnetothermal protection is coordinated to the protection of indirect contacts.

CAUTION



The instrument must be used to measure a fault loop impedance value which is at least ten times higher than the instrument's resolution, so as to minimize possible errors.

13.7.2. Installation parts to be checked

The test is necessary in TN or IT electrical system without RCDs.

13.7.3. Allowable values

The following relation has to be fulfill:

$$Z_S \leq U_o / I_a$$

ove: U_o = phase to earth voltage.

Z_S = impedance measured between phase and earth.

I_a = tripping current of the magnetothermal protection in 5 seconds.

13.8. EARTH RESISTANCE MEASUREMENT IN TT SYSTEMS

13.8.1. Purpose of the test

Check that the RCD is coordinated with the earth resistance value. It is not possible to assume an earth resistance value as reference limit when controlling the test result, while it is necessary to check every time that the co-ordination complies with the requirements of the standards.

13.8.2. Installation parts to be checked

The earth installation under working conditions. The check is to be effected without disconnecting the earth plates.

13.8.3. Allowable values

The earth resistance value measured shall meet the following relation:

$$R_A < 50 / I_a$$

where: R_A = resistance of the earth installation, the value can be set with the following measurements:

- earth resistance with three-wire volt-ampere method
- fault loop impedance (see (*))
- two-wire earth resistance (see (**))
- two-wire earth resistance in the socket (see (**))
- earth resistance obtained by the measurement of contact voltage U_t (see (**))
- earth resistance obtained by the tripping time test of the RCDs (A, AC), RCDs S (A, AC) (see (**)).

I_a = tripping current in 5s of the RCD; rated tripping current of the RCD (in the case of RCD S 2 IdN

50 = safety limit voltage (reduced down to 25V in special rooms)

(*) If the installation is protected by an RCD the measurement shall be effected upstream or downstream the RCD short circuiting it to avoid its tripping.

(**) These methods provide values resulted to be indicative of the earth resistance.

EXAMPLE FOR EARTH RESISTANCE TEST

Let's assume an installation protected by a 30 mA RCD. Let's measure the earth resistance using one of the methods quoted above, to evaluate whether the installation resistance is complying with the standards in force and multiply the result by 0.03A (30 mA). If the result is lower than 50V (or 25V for special rooms) the installation can be considered as coordinated as it respects the above-said relation.

When we face 30 mA RCDs (the most of civil installations) the maximum earth resistance allowed is $50/0.03=1666\Omega$ permitting to use even simplified methods which even though they do not provide extremely precise values give a value approximate enough for the calculation of the co-ordination.

13.9. VOLTAGE AND CURRENT HARMONICS

13.9.1. Theory

Any periodical non-sine wave can be represented as a sum of sinusoidal waves having each a frequency that corresponds to an entire multiple of the fundamental, according to the relation:

$$v(t) = V_0 + \sum_{k=1}^{\infty} V_k \sin(\omega_k t + \varphi_k) \quad (1)$$

where: V_0 = average value of $v(t)$
 V_1 = amplitude of the fundamental of $v(t)$
 V_k = amplitude of the k^{th} harmonic of $v(t)$

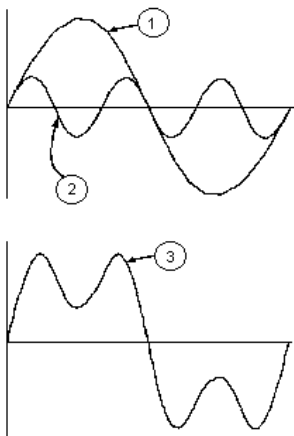

LEGEND:

1. Fundamental
2. Third harmonic
3. Distorted waveform

Fig. 35: Effect of the sum of two multiple frequencies

In the mains voltage, the fundamental has a frequency of 50 Hz, the second harmonic has a frequency of 100 Hz, the third harmonic has a frequency of 150 Hz and so on. Harmonic distortion is a constant problem and should not be confused with short events such as sags, surges or fluctuations.

It can be noted that in (1) the index of the sigma is from 1 to the infinite. What happens in reality is that a signal does not have an unlimited number of harmonics: a number always exists after which the harmonics value is negligible. The EN 50160 standard recommends to stop the index in the expression (1) in correspondence of the 40th harmonic. A fundamental element to detect the presence of harmonics is THD defined as:

$$THD_v = \frac{\sqrt{\sum_{h=2}^{40} V_h^2}}{V_1}$$

This index takes all the harmonics into account. The higher it is, the more distorted the waveform gets.

13.9.2. Limit values for harmonics

EN 50160 guideline fixes the limits for the harmonic voltages, which can be introduced into the network by the power supplier. In normal conditions, during whatever period of a week, 95% if the RMS value of each harmonic voltage, mediated on 10 minutes, will have to be inferior than or equal to the values stated in Table 6. The total harmonic distortion (THD) of the supply voltage (including all the harmonics up to 40th order) must be inferior than or equal to 8%.

Odd harmonics				Even harmonics	
Not multiple of 3		Multiple of 3		Order h	Relative voltage % Max
Order h	Relative voltage % Max	Order h	Relative voltage % Max		
5	6	3	5	2	2
7	5	9	1,5	4	1
11	3,5	15	0,5	6..24	0,5
13	3	21	0,5		
17	2				
19	1,5				
23	1,5				
25	1,5				

Table 6: Limits for the harmonic voltages the supplier may introduce into the network

These limits, theoretically applicable only for the supplier of electric energy, provide however a series of reference values within which the harmonics introduced into the network by the users must be contained.

13.9.3. Presence of harmonics: causes

Any apparatus that alters the sine wave or uses only a part of such a wave causes distortions to the sine wave and therefore harmonics.

All current signals result in some way virtually distorted. The most common situation is the harmonic distortion caused by non-linear loads such as electric household appliances, personal computers or speed control units for motors. Harmonic distortion causes significant currents at frequencies that are odd multiples of the fundamental frequency. Harmonic currents affect considerably the neutral wire of electric installations.

In most countries, the mains power is three-phase 50/60Hz with a delta primary and star secondary transformers. The secondary generally provides 230V AC from phase to neutral and 400V AC from phase to phase. Balancing the loads on each phase has always represented an headache for electric systems designers.

Until some ten years ago, in a balanced system, the vectorial sum of the currents in the neutral was zero or quite low (given the difficulty of obtaining a perfect balance). The devices were incandescent lights, small motors and other devices that presented linear loads. The result was an essentially sinusoidal current in each phase and a low current on the neutral at a frequency of 50/60Hz.

“Modern” devices such as TV sets, fluorescent lights, video machines and microwave ovens normally draw current for only a fraction of each cycle thus causing non-linear loads and subsequent non-linear currents. All this generates odd harmonics of the 50/60Hz line frequency. For this reason, the current in the transformers of the distribution boxes contains only a 50Hz (or 60Hz) component but also a 150Hz (or 180Hz) component, a 50Hz (or 300Hz) component and other significant components of harmonic up to 750Hz (or 900Hz) and higher.

The vectorial sum of the currents in a balanced system that feeds non-linear loads may still be quite low. However, the sum does not eliminate all current harmonics. The odd multiples of the third harmonic (called “TRIPLENS”) are added together in the neutral and can cause overheating even with balanced loads.

13.9.4. Presence of harmonics: consequences

In general, even harmonics, i.e. the 2nd, 4th etc., do not cause problems. Triple harmonics, odd multiples of three, are added on the neutral (instead of cancelling each other) thus creating a condition of overheating of the wire which is extremely dangerous. Designers should take into consideration the three issues given below when designing a power distribution system that will contain harmonic current:

- the neutral wire must be of sufficient gauge
- the distribution transformer must have an additional cooling system to continue operating at its rated capacity when not suited to the harmonics. This is necessary because the harmonic current in the neutral wire of the secondary circuit circulates in the delta-connected primary circuit. This circulating harmonic current heats up the transformer
- phase harmonic currents are reflected on the primary circuit and continue back to the power source. This can cause distortion of the voltage wave so that any power factor correction capacitors on the line can be easily overloaded.

The 5th and the 11th harmonic contrast the current flow through the motors making its operation harder and shortening their average life. In general, the higher the ordinal harmonic number, the smaller its energy is and therefore the impact it will have on the devices (except for transformers).

13.10. POWER AND POWER FACTOR DEFINITION

In un generico sistema elettrico, alimentato da una terna di tensioni sinusoidali, si In a standard electric installation powered by three sine voltages the following is defined:

Phase active power: (n=1,2,3)	$P_n = V_{nN} \cdot I_n \cdot \cos(\varphi_n)$
Phase reactive power: (n=1,2,3)	$Q_n = \sqrt{S_n^2 - P_n^2}$
Phase apparent power: (n=1,2,3)	$S_n = V_{nN} \cdot I_n$
Phase power factor: (n=1,2,3)	$P_{Fn} = \frac{P_n}{S_n}$
Total active power:	$P_{TOT} = P_1 + P_2 + P_3$
Total reactive power:	$Q_{TOT} = Q_1 + Q_2 + Q_3$
Total apparent power:	$S_{TOT} = \sqrt{P_{TOT}^2 + Q_{TOT}^2}$
Total power factor:	$P_{FTOT} = \frac{P_{TOT}}{S_{TOT}}$

where: V_{nN} = RMS value of voltage between phase n and neutral
 I_n = RMS value of n phase current
 φ_n = phase displacement angle between voltage and current of n phase

In presence of distorted voltages and currents the previous relations vary as follows:

Phase active power: (n=1,2,3)	$P_n = \sum_{k=0}^{\infty} V_{kn} I_{kn} \cos(\varphi_{kn})$
Phase reactive power: (n=1,2,3)	$Q_n = \sqrt{S_n^2 - P_n^2}$
Phase apparent power: (n=1,2,3)	$S_n = V_{nN} \cdot I_n$
Phase power factor: (n=1,2,3)	$P_{Fn} = \frac{P_n}{S_n}$
Distorted power factor (n=1,2,3)	$\text{dPF}_n = \cos \varphi_{1n} =$ phase displacement between the fundamentals of voltage and current of n phase
Total active power:	$P_{TOT} = P_1 + P_2 + P_3$
Total reactive power:	$Q_{TOT} = Q_1 + Q_2 + Q_3$
Total apparent power:	$S_{TOT} = \sqrt{P_{TOT}^2 + Q_{TOT}^2}$
Total power factor:	$P_{FTOT} = \frac{P_{TOT}}{S_{TOT}}$

where: V_{kn} = RMS value of k^{th} voltage harmonic between n phase and neutral
 I_{kn} = RMS value of k^{th} current harmonic of n phase
 φ_{kn} = Phase displacement angle between k^{th} voltage harmonic and k^{th} current harmonic of n phase

13.10.1. Note

It is to be noted that the expression of the phase reactive power with non sine waveforms, would be wrong. To understand this, it may be useful to consider that both the presence of harmonics and the presence of reactive power produce, among other effects, an increase of line power losses due to the increased current RMS value. With the above given relation the increasing of power losses due to harmonics is added to that introduced by the presence of reactive power. In effect, even if the two phenomena contribute together to the increase of power losses in line, it is not true in general that these causes of the power losses are in phase between each other and therefore that can be added one to the other mathematically. The above given relation is justified by the relative simplicity of calculation of the same and by the relative discrepancy between the value obtained using this relation and the true value.

It is to be noted moreover, how in case of an electric installation with harmonics, another parameter called distorted power factor (dPF) is defined. In practice, this parameter represents the theoretical limit value that can be reached for power factor if all the harmonics could be eliminated from the electric installation.

13.10.2. Conventions on powers and power factors

As for the recognition of the type of reactive power, of the type of power factor and of the direction of the active power, the below conventions must be applied. The stated angles are those of phase-displacement of the current compared to the voltage (for example, in the first panel the current is in advance from 0° to 90° compared to the voltage):

Equipment under test = inductive generator
Equipment under test = capacitive load

90°				0°	
	P+ = 0	P- = P	P+ = P	P- = 0	
	Pfc+ = -1	Pfc- = -1	Pfc+ = Pf	Pfc- = -1	
	Pfi+ = -1	Pfi- = Pf	Pfi+ = -1	Pfi- = -1	
	Qc+ = 0	Qc- = 0	Qc+ = Q	Qc- = 0	
180°	Qi+ = 0	Qi- = Q	Qi+ = 0	Qi- = 0	
	P+ = 0	P- = P	P+ = P	P- = 0	
	Pfc+ = -1	Pfc- = Pf	Pfc+ = -1	Pfc- = -1	
	Pfi+ = -1	Pfi- = -1	Pfi+ = Pf	Pfi- = -1	
	Qc+ = 0	Qc- = Q	Qc+ = 0	Qc- = 0	
	Qi+ = 0	Qi- = 0	Qi+ = Q	Qi- = 0	
270°					

Equipment under test = capacitive generator
Equipment under test = inductive load

where:

Symbol	Significance	Remarks
P+	Value of the active power +	Positive parameter (user)
Pfc+	Capacitive power factor +	
Pfi+	Inductive power factor +	
Qc+	Value of the capacitive reactive power +	
Qi+	Value of the inductive reactive power +	
P-	Value of the active power -	Negative parameter (generator)
Pfc-	Capacitive power factor -	
Pfi-	Inductive power factor -	
Qc-	Value of the capacitive reactive power -	
Qi-	Value of the inductive reactive power -	

Value	Significance
P	The active power (positive or negative) is defined in the panel and therefore acquires the value of the active power in that moment
Q	The reactive power (inductive or capacitive, positive or negative) is defined in the panel and therefore acquires the value of the reactive power in that moment
Pf	The power factor (inductive or capacitive, positive or negative) is defined in the panel and therefore acquires the value of the power factor in that moment
0	The active power (positive or negative) or the reactive power (inductive or capacitive, positive or negative) is NOT defined in the panel and therefore acquires a null value
-1	The power factor (inductive or capacitive, positive or negative) is NOT defined in the panel



Via della Boaria 40
48018 – Faenza (RA) - Italy
Tel: +39-0546-621002 (4 linee r.a.)
Fax: +39-0546-621144
email: ht@htitalia.it
<http://www.ht-instruments.com>